

TASCAM

D01276520A

DR-701D

Linear PCM Recorder for DSLR

REFERENCE MANUAL

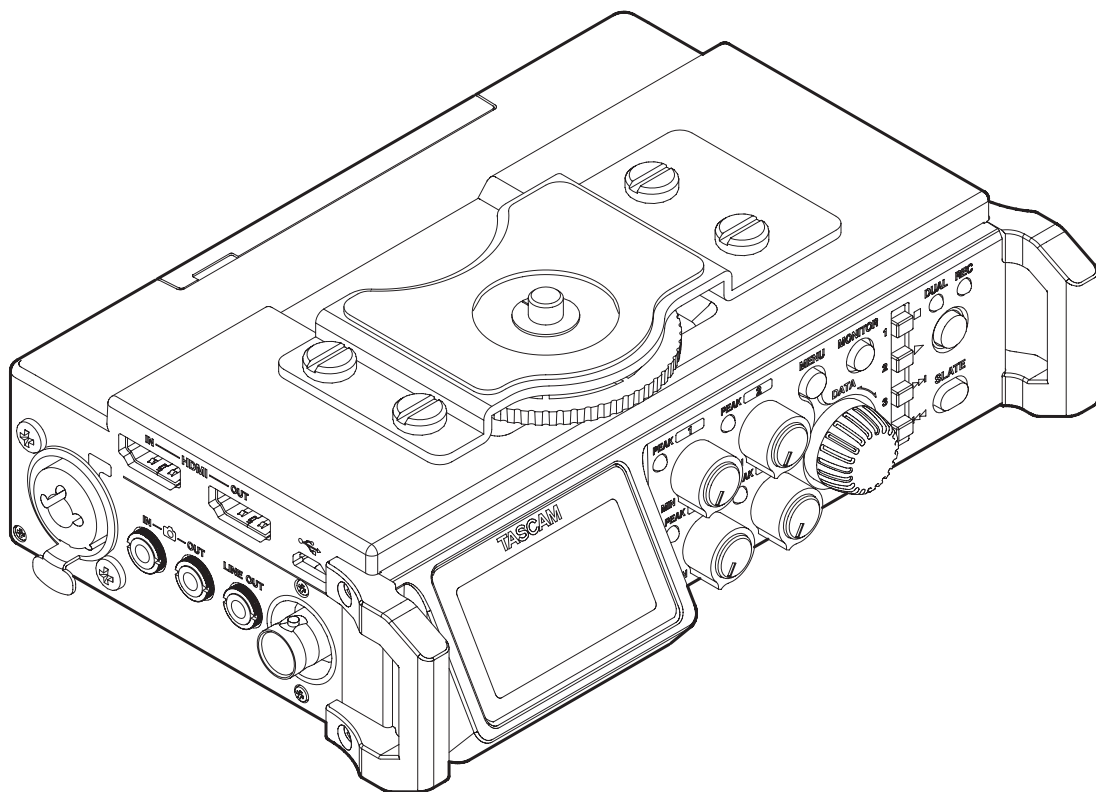

HDMI[®]
HIGH-DEFINITION MULTIMEDIA INTERFACE

BLACK
PROCESSOR
by
Analog Devices

Contents

1 – Introduction	4	Compensating for mic distances.....	21
Features	4	Setting phase reversal for individual channels	21
Conventions used in this manual	4	Set the power sources used by mics.....	22
Trademarks.....	5	Setting phantom power	22
About SD cards	5	Setting the phantom power voltage	22
Precautions for use	5	Setting plug-in power	23
2 – Names and functions of parts	6	Using the limiter	23
Front panel	6	Setting automatic level control (ALC).....	24
Rear panel.....	6	Setting the low-cut filter	24
Left side	7	Setting the recording file type, file format and sampling frequency.....	24
Right side	8	Setting channels to record	25
Top.....	8	Make MIX channel recording settings.....	25
Bottom	9	Recording (MONO/STEREO/POLY (6ch))	25
Home Screen	9	Starting recording.....	25
Menu structure	10	File names when the FILE TYPE is MONO.....	25
Basic Menu Screen operations.....	12	File names when the FILE TYPE is STEREO	25
Menu operation procedures.....	12	File names when POLY (6ch) recording.....	25
Basic operation	12	Creating a new file while continuing to record (file incrementing)	26
3 – Preparation.....	13	Manually incrementing files during recording	26
Powering the unit	13	Automatically incrementing files during recording.....	26
Power sources	13	Simultaneously recording two files at different input levels (DUAL REC)	26
Using AA batteries	13	Enabling dual recording	26
Using an AC adapter (sold separately).....	13	Starting dual recording.....	26
Using an external battery pack (sold separately).....	13	Dual recording file names.....	26
Using USB bus power.....	14	Using mark functions.....	27
Turning the power on and off (putting it in standby)	14	Adding marks manually to a recording	27
Turning the unit on.....	14	Moving to a mark position.....	27
Turning the unit off (putting it in standby).....	14	Using the auto tone function	27
Resume function	14	Setting the auto tone function	27
Setting the date and time.....	15	Setting the volume of auto tones and slate tones	27
Inserting and removing SD cards.....	15	Using the oscillator.....	27
Inserting the card	15	Recording slate tones.....	28
Removing the card	15	Moving to slate tone insertion positions.....	28
SD card write protection switches	15	Inputting time code and adding recording start times to files.....	28
Preparing an SD card for use	16	Setting the time code source input.....	28
Camera connections.....	16	Setting the power off generator function	29
Setting the input functions.....	17	Checking the time code counter	29
Recording with the built-in mics	17	Outputting this unit's audio as the HDMI output audio.....	29
Connecting microphones	17	Outputting the audio of each input channel from the HDMI output.....	29
Recording an external device (LINE IN).....	17	Outputting the MIX audio from the HDMI output	29
Connecting a time code generator	17	Recording duration	30
Connecting monitoring equipment	18		
Adjusting the playback volume.....	18		
Monitoring.....	19		
Selecting the monitored signals.....	19		
Using the accessory shoe on the top panel	19		
4 – Recording	20		
Setting where to save files.....	20		
Setting the recording input sources	20		
Adjusting the input level.....	20		

5 – Working with Files and Folders (Browse Screen)	31
Navigating the Browse Screen	31
Icons on the Browse Screen	31
File operations	31
Folder operations.....	32
Creating a new folder	32
Using the MEDIA menu page to create a folder	32
Using NEW FOLDER on the Browse Screen.....	32
6 – Playback.....	33
Playing recordings.....	33
Pausing playback.....	33
Stopping playback.....	33
Searching backward and forward.....	33
Jumping between playback positions.....	33
Playing dual recording files.....	33
7 – Mixer	34
Setting the mixer	34
Using mid-side microphones	34
Adjusting the stereo width.....	34
Setting the GANG operation mode.....	34
8 – Connecting with a Computer	35
Transferring files to a computer	35
Transferring files from a computer	35
Disconnecting from a computer	35
9 – Settings and Information	36
Setting the file name format	36
Setting the WORD item.....	36
Resetting the count.....	36
Format an SD card	36
Adjusting the display contrast	37
Setting the peak hold time.....	37
Setting trim operation mute.....	37
Making power management settings.....	37
Setting the type of batteries.....	37
Set the automatic power saving function.....	37
Setting the backlight	37
Restoring factory default settings	37
Viewing File Information.....	38
File information page (PROJECT).....	38
Card information page (CARD).....	38
System information page (SYSTEM)	38
10 – Using the REMOTE jack.....	39
Using a footswitch (TASCAM RC-3F).....	39
Setting up the footswitch	39
Using the footswitch.....	39
Using a remote control (TASCAM RC-10)	39
Setting up a remote control.....	39
Using the remote control	39
11 – Messages.....	40
12 – Troubleshooting.....	41
13 – Specifications	42
General	42
Input/output ratings.....	42
Analog audio input and output ratings.....	42
Control input/output ratings	42
Audio performance.....	43
General	43
Dimensional drawings	44

1 – Introduction

Features

This audio recorder includes audio outputs and functions designed for use with digital single-lens reflex (DSLR) cameras and video cameras, enabling the recording of high-quality audio.

- Compact audio recorder that uses SD/SDHC/SDXC cards as recording media
- TASCAM High Definition Discrete Architecture (HDDA) microphone preamps provide high-quality recording inputs
- Four channels can be mixed down to two for stereo output
- Recording levels can be adjusted independently for all channels
- GANG trim function enables linked control of multiple trims while retaining level differences
- Clock synchronization with a camera possible using an HDMI connection
- Support for HDMI time code recording triggers
- Support for HDMI time code and LTC time code input (time code time embedded in BWF Time Reference)
- Audio recorded by this unit can be added to images from the HDMI input and then output by HDMI
- Dual recording function allows two files to be recorded simultaneously at different levels
- Simultaneous recording of up to 4 channels and a stereo mix possible (4+2)
- 44.1/48/96/192 kHz, 16/24-bit, linear PCM (WAV format) recording possible
- Broadcast Wave Format (BWF) supported as WAV recording format
- XLR mic/line inputs can provide phantom power (24/48V)
- TRS mic/line inputs support +24dBu input when set to LINE
- Stereo mini jack input supports mics that require plug-in power, allowing the input of video mics and other high-output mics (+10dBV maximum input level)
- Slate tone functions (automatic/manual) simplify synchronization of video files when editing
- Camera out connector allows the high-quality audio from this unit to be output to a DSLR camera for recording
- Camera in connector enables convenient monitoring of audio from a DSLR camera
- Mid-side decoding function can be used with MS mics
- File incrementing function allows a recording to be split by creating a new file when desired
- Automatic level control can be used to control recording levels in response to input signal volumes
- Multiband limiter can automatically reduce just parts with input levels that are too high to suitable levels
- Low cut filter conveniently reduces low-frequency noise
- Delay function eliminates time lags caused by the different distances of two input sources
- Tone search function can move to points where slate tones were input
- Marks can be set where desired during recording
- File name format can be set to use a user-defined word or the date
- Resume function remembers the playback position before the unit was turned off (put in standby)
- 3.5mm (1/8") line and headphones output jacks
- 128x64 dot-matrix LCD with backlight
- Micro-B USB 2.0 port
- Operates on 4 AA batteries, a TASCAM PS-P515U AC adapter (sold separately), a TASCAM BP-6AA external battery pack (sold separately) or USB bus power
- Tripod mounting threads (bottom) and DSLR screw attachment that allows attachment and removal with a coin (top)
- Dedicated remote control jack for use with RC-10 and RC-3F (sold separately)
- HOLD switch to prevent accidental operation
- Handles on the front left and right sides protect the screen

This product has a Blackfin® 16/32-bit embedded processor made by Analog Devices, Inc. This processor controls the unit's digital signal processing.

Inclusion of this Blackfin® processor in the product increases its performance and reduces its power consumption.

Conventions used in this manual

The following conventions are used in this manual.

- When we refer to buttons, connectors and other parts of this unit, we use a bold font like this: **MENU** button.
- When we show messages, for example, that appear on the unit's display, the typeface looks like this: M I X.
- "SD card" indicates SD, SDHC and SDXC memory cards.
- Information shown on a computer display is written like this: "OK".
- Additional information is provided as necessary as tips, notes and cautions.

TIP

These are tips about how to use the unit.

NOTE

These provide additional explanations and describe special cases.

CAUTION

Failure to follow these instructions could result in injury, damage to equipment or lost recording data, for example.

Trademarks

- TASCAM is a trademark of TEAC CORPORATION, registered in the U.S. and other countries.
- The terms HDMI and HDMI High-Definition Multimedia Interface, and the HDMI Logo are trademarks or registered trademarks of HDMI Licensing LLC in United States and other countries.
- The SDXC logo is a trademark of SD-3C, LLC.



- Blackfin® and the Blackfin logo are registered trademarks of Analog Devices, Inc.
- Other company names, product names and logos in this document are the trademarks or registered trademarks of their respective owners.

Information is given about products in this manual only for the purpose of example and does not indicate any guarantees against infringements of third-party intellectual property rights and other rights related to them. TEAC Corporation will bear no responsibility for infringements on third-party intellectual property rights or other liabilities that occur as a result of the use of this product.

Properties copyrighted by third parties cannot be used for any purpose other than personal enjoyment and the like without the permission of the right holders recognized by copyright law. Always use this equipment properly.

TEAC Corporation will bear no responsibility for rights infringements committed by users of this product.

About SD cards

This unit uses SD cards for recording and playback.

It can use 64MB–2GB SD cards, 4–32GB SDHC cards and 48–128GB SDXC cards.

A list of SD cards that have been confirmed for use with this unit can be found on the TEAC Global Site (<http://teac-global.com>). You can also contact TASCAM customer support for information.

Precautions for use

SD cards are delicate media. In order to avoid damaging SD cards, please take the following precautions when handling them.

- Do not leave them in extremely hot or cold places.
- Do not leave them in extremely humid places.
- Do not let them get wet.
- Do not put things on top of them or twist them.
- Do not hit them.
- Do not remove or insert them during recording, playback, data transmission or other access.
- When transporting them, put them into cases, for example.

2 – Names and functions of parts

Front panel

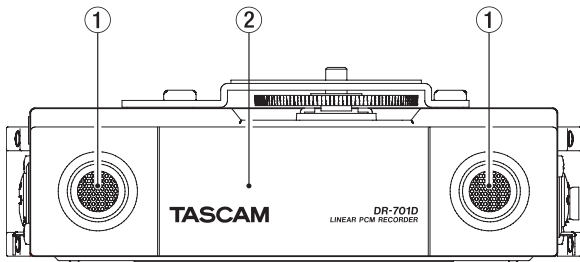

- ① **Built-in stereo microphone**
This stereo microphone uses two omnidirectional electret condenser mics.
- ② **Front cover**
This covers the battery compartment and the SD slot.

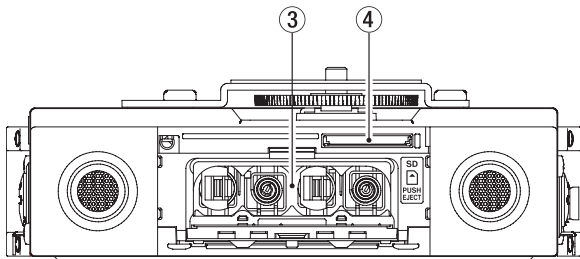

- ③ **Battery compartment**
Install batteries (4 AA) in this compartment to power the unit.(see “Using AA batteries” on page 13)
- ④ **SD card slot**
Insert an SD card here.

Rear panel

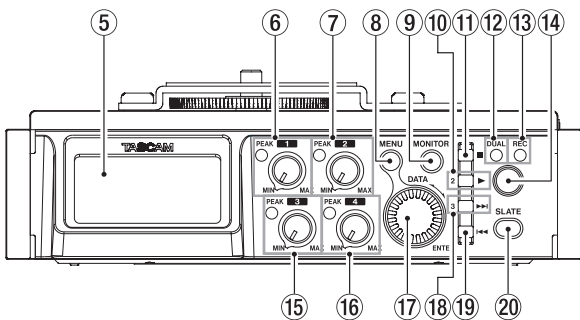

- ⑤ **Display**
This shows a variety of information.
- ⑥ **1 knob and PEAK indicator**
Use the 1 knob to adjust the input level from the **IN 1** connector on the left side of the unit.
The **1 PEAK** indicator lights when the input level is about to cause distortion.
During mic input, this also lights if distortion occurs in the analog circuitry. During line level input, this does not light even if distortion occurs in the analog circuitry.(see “Adjusting the input level” on page 20)

- ⑦ **2 knob and PEAK indicator**
Use the 2 knob to adjust the input level from the **IN 2** connector on the left side of the unit.
The **2 PEAK** indicator lights when the input level is about to cause distortion.
During mic input, this also lights if distortion occurs in the analog circuitry. During line level input, this does not light even if distortion occurs in the analog circuitry.(see “Adjusting the input level” on page 20)

- ⑧ **MENU button**
When the Home Screen is open, press this button to open the Menu Screen.
When a setting screen is open, press to move up one level in the menu. When the Menu Screen is open, press to return to the Home Screen.

- ⑨ **MONITOR button**
When not playing back, press to open the monitoring source selection menu.

- ⑩ **2/▶ button**
When the Home Screen is open and the unit is stopped, press this button to start playback.
When a file or folder is selected on the Browse Screen, press this button to return to the Home Screen and play the file or the first file in the folder from the beginning.
Press this button when a CH1/CH2/CH3/CH4 item on a menu page is shown to move the cursor to the channel 2 setting.

- ⑪ **1/■ button**
Press this button during playback to stop playback and return to the beginning of that playback file.
Press this button during recording to stop recording.
Press this button when a CH1/CH2/CH3/CH4 item on a menu page is shown to move the cursor to the channel 1 setting.
Use this button to answer “NO” to a confirmation message when using a setting screen.

- ⑫ **DUAL indicator**
This lights orange when in dual recording mode.

- ⑬ **REC indicator**
This lights red when recording.

- ⑭ **Record (●) button**
Press when stopped to start recording.

- ⑮ **3 knob and PEAK indicator**
Use the 3 knob to adjust the input level from the **IN 3** connector on the left side of the unit.
The **3 PEAK** indicator lights when the input level is about to cause distortion. During mic input, this also lights if distortion occurs in the analog circuitry. During line level input, this does not light even if distortion occurs in the analog circuitry.(see “Adjusting the input level” on page 20)

- ⑯ **4 knob and PEAK indicator**
Use the 4 knob to adjust the input level from the **IN 4** connector on the right side of the unit.
The **4 PEAK** indicator lights when the input level is about to cause distortion. During mic input, this also lights if distortion occurs in the analog circuitry. During line level input, this does not light even if distortion occurs in the analog circuitry.(see “Adjusting the input level” on page 20)

2 – Names and functions of parts

- 17 DATA dial (ENTER)**
Turn to select items and change values on setting screens.
Push to confirm selections on setting screens and to answer “YES” to confirmation pop-up messages.
Press during recording to add a mark manually.(see “Using mark functions” on page 27)
- 18 3/▶▶▶ button**
Press this button during playback or when stopped to move to the previous mark. When there are no marks, press to skip to the next file.
Press and hold this button to search forward.
Press this button when a CH1/CH2/CH3/CH4 item on a menu page is shown to move the cursor to the channel 3 setting.
On the setting screens, use this button to move the cursor right.
If a file is selected, the file is loaded and the unit returns to the Home Screen.
- 19 4/◀◀◀ button**
Press this button to move to the previous mark during playback or when stopped in the middle of a file. When there are no marks, press to return to the beginning of the playback file.
If you press this button when a file is stopped at its beginning, the unit will skip to the beginning of the previous file.
Press and hold this button to search backwards.
Press this button when a CH1/CH2/CH3/CH4 item on a menu page is shown to move the cursor to the channel 4 setting.
On the setting screens, use this button to move the cursor left.
- 20 SLATE button**
Press and hold during recording, playback or monitoring to record a slate stone.(see “Recording slate tones” on page 28)

Left side

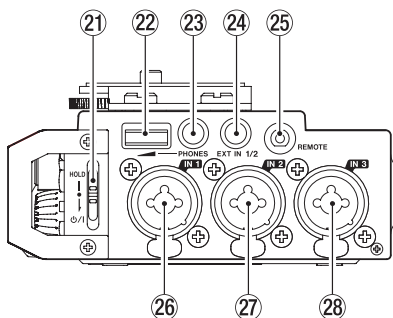

NOTE

When connecting and using plugs from external devices, do not apply excessive force to the plugs. In particular, be careful not to apply too much force when using a standard to mini plug adapter. Doing so could damage the equipment.

- 21 HOLD/OFF switch**
Slide this switch down (in the direction of the arrow) to turn the unit on/off.
Set it to the top position to activate the hold function. All buttons are inoperative when hold is ON.
- 22 PHONES volume**
Use to adjust the volume output from the PHONES jack.
- CAUTION**
Before connecting headphones, lower the PHONES volume to the minimum level. Failure to do so could result in a sudden loud noise that could harm hearing, for example.
- 23 PHONES jack (3.5mm stereo mini jack)**
Connect stereo headphones to this stereo mini jack.
Use the PHONES control to adjust the volume.
- 24 EXT IN 1/2 connector (3.5mm stereo mini jack)**
Use this input jack to connect a stereo mini jack mic or an external device.
This jack provides plug-in power.
TRS (Tip: HOT, Ring: COLD, Sleeve: GND)
- 25 REMOTE jack (2.5mm TRS jack)**
Connect a TASCAM RC-3F footswitch or TASCAM RC-10 wired remote control (both sold separately) here. This enables remote starting and stopping of playback and other functions.(see “10 – Using the REMOTE jack” on page 39)
- 26 IN 1 connector (XLR/TRS)**
This balanced analog jack is an XLR mic and standard TRS jack input.
XLR (1: GND, 2: HOT, 3: COLD)
TRS (Tip: HOT, Ring: COLD, Sleeve: GND)
- 27 IN 2 connector (XLR/TRS)**
This balanced analog jack is an XLR mic and standard TRS jack input.
XLR (1: GND, 2: HOT, 3: COLD)
TRS (Tip: HOT, Ring: COLD, Sleeve: GND)
- 28 IN 3 connector (XLR/TRS)**
This balanced analog jack is an XLR mic and standard TRS jack input.
XLR (1: GND, 2: HOT, 3: COLD)
TRS (Tip: HOT, Ring: COLD, Sleeve: GND)

CAUTION

- Confirm that phantom power is OFF before connecting a line level device to an IN 1, IN 2, IN 3 or IN 4 connector. If you connect a line level device while phantom power is being supplied, that device and this unit could be damaged.
- When using a condenser microphone, before connecting to or disconnecting from an IN 1, IN 2, IN 3 or IN 4 connector, confirm that the phantom power for that jack is OFF. If you connect or disconnect a mic while phantom power is being supplied, that mic and this unit could be damaged.
- Turn phantom power ON only when using a condenser microphone that requires phantom power. Turning phantom power on when a dynamic mic or other mic that does not require it is connected could damage this unit and connected equipment.
- When using condenser mics that require phantom power and dynamic mics together, be sure to use balanced dynamic mics. Unbalanced dynamic mics cannot be used when phantom power is enabled.

2 – Names and functions of parts

Right side

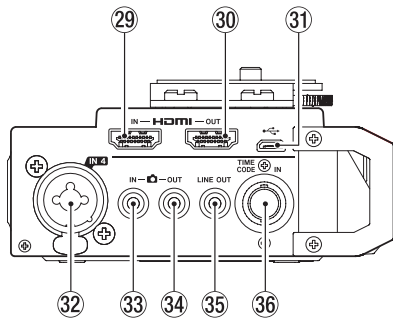

NOTE

When connecting and using plugs from external devices, do not apply excessive force to the plugs. In particular, be careful not to apply too much force when using a standard to mini plug adapter. Doing so could damage the equipment.

- ②9 **HDMI IN port**
Connect a DSLR camera or other HDMI source device here.
- ③0 **HDMI OUT port**
Connect an HDMI monitor or other HDMI sync device here.
- ③1 **Micro USB port**
Use the included USB cable to connect with a computer USB port. (see “8 – Connecting with a Computer” on page 35)
Power can be supplied through the USB cable provided with the unit or a TASCAM PS-P515U AC adapter (sold separately).

CAUTION

The unit should be connected directly to the computer, not through a USB hub.

- ③2 **IN 4 connector (XLR/TRS)**
This balanced analog jack is an XLR mic and standard TRS jack input.
XLR (1: GND, 2: HOT, 3: COLD)
TRS (Tip: HOT, Ring: COLD, Sleeve: GND)
- ③3 **IN connector (3.5mm stereo mini jack)**
Use a stereo mini jack cable to connect this with the camera audio output jack.
Refer to the camera's operation manual to identify connectors on the camera. (see “Camera connections” on page 16)
- ③4 **OUT jack (3.5mm stereo mini jack)**
Use a stereo mini jack cable to connect this with the camera external input jack.
Use the **OUTPUT LEVEL** page **CAMERA** item to adjust the volume output from this jack. (see “Adjusting the playback volume” on page 18)
Refer to the camera's operation manual to identify connectors on the camera. (see “Camera connections” on page 16)
- ③5 **LINE OUT jack (3.5mm stereo mini jack)**
Use a stereo mini jack cable to connect this with the line input jack of an external device.
Use the **OUTPUT LEVEL** page **LINE** item to adjust the volume output from this jack. (see “Adjusting the playback volume” on page 18)

- ③6 **TIME CODE IN connector**
Use a BNC cable to connect this with the time code output connector of an external device. (see “Connecting a time code generator” on page 17)

Top

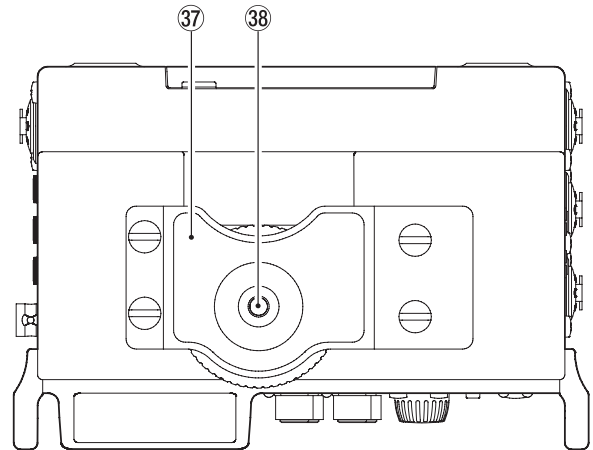

- ③7 **DSLR camera attachment bracket**
Use this bracket, which is preinstalled on the unit, with the DSLR mounting screw.
If you do not want to use this bracket, use a coin or other tool to remove the four attachment screws.
- ③8 **DSLR camera mounting screw (1/4-inch)**
Use to attach this unit to the bottom of a camera or a rack that supports camera mounting screws, for example.

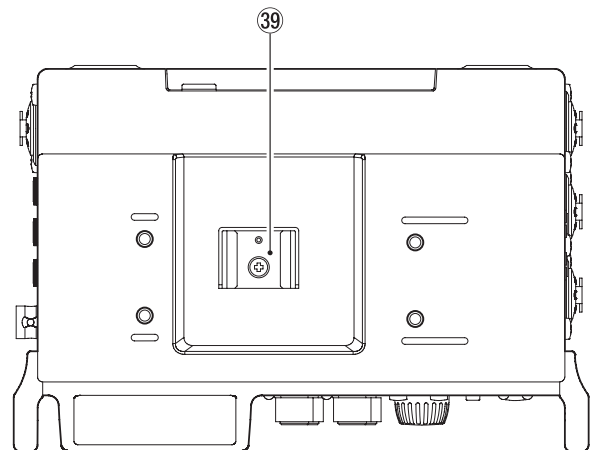

- ③9 **Accessory shoe**
You can remove the included DSLR camera attachment bracket to use the accessory shoe.

2 – Names and functions of parts

Bottom

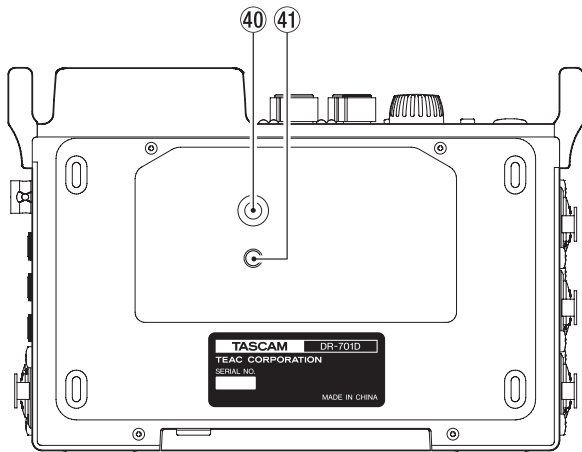

- ④① **Tripod mounting threads (1/4-inch)**
Use to attach this unit to a tripod.

CAUTION

- Securely tighten all the screws on the tripod or microphone stand to prevent the unit from falling off.
- Place the tripod or microphone stand on a level surface when using it with this unit.
- Some tripods have different screw specifications that make direct connection impossible. Use a commercially-available adapter with such tripods.

- ④① **Video camera pin hole**
When using a tripod with a pin for video cameras, align this hole with the pin when attaching the unit to the tripod.

Home Screen

The unit's Home Screen has a counter display mode and a trim display mode.

When the Home Screen is open, press the **DATA** dial to change the display mode.

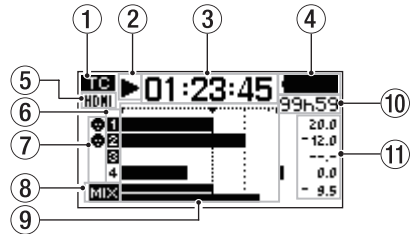

Home Screen counter display mode

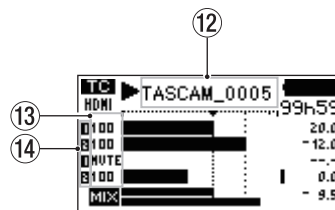

Home Screen trim display mode

- ① **Time code reception status**
This shows the time code reception status.(see "Inputting time code and adding recording start times to files" on page 28)
No indicator: time code not being received
TIC: time code being received

- ② **Recorder operation status**
This icon shows the recorder operation status.







Indicator	Meaning
■	Stopped
	Paused
▶	Playing back
▶▶	Searching forward
◀◀	Searching backward
▶▶	Skipping to the beginning of the next file
◀◀	Skipping to the beginning of the current or previous file
●	Recording

- ③ **Elapsed time**
This shows the elapsed time (hours: minutes: seconds) of the current file.
- ④ **Power supply status**
A battery icon appears when power is supplied by batteries. The icon shows the amount of battery power remaining with 25 levels (■■■■ → ■■■ → ■■■■).
The battery is almost dead and the unit will soon turn off (enter standby) if the □ icon appears empty and blinks. When using the PS-P515U AC adapter (sold separately) or USB bus power, □➡ appears. Even when using bus power, you can check the unit's remaining battery power with an 8-level indicator.

2 – Names and functions of parts

NOTE

Sometimes a **Battery Low warning** appears when recording or conducting other demanding operations even when battery power remains.

- ⑤ **HDMI connection status**
This shows the HDMI connection status.
No indicator: ; HDMI not connected
HDMI: HDMI connected
: HDMI connected (clock sync)
- ⑥ **Recording setting status**
These show whether or not recording is enabled. (see “Setting channels to record” on page 25)
: recording not enabled
: recording enabled
- ⑦ **Phantom power status**
These show whether phantom power is on or off.(see “Setting phantom power” on page 22)
No icon: Phantom power off
: Phantom power on
- ⑧ **MIX recording setting status**
MIX: MIX recording off
: MIX recording on
- ⑨ **Level meters**
These show the levels of the input and playback signals.
The dotted lines at the –20dB (▼ mark) and –12dB positions are guides for input level adjustment.
- ⑩ **Remaining time**
When playing back, this shows the remaining time (hours: minutes) of the current file.
When recording, this shows the remaining time (hours: minutes) of the SD card.
- ⑪ **Peak values in decibels (dB)**
During playback, the maximum level that occurs in a fixed period of time is shown in decibels for each channel.
During recording, the peak input level values are shown in decibels.
- ⑫ **Project name**
This shows the name of the project being recorded or playing back.
A project is a group of files used for recording/playback.
- ⑬ **Trim values**
These show the settings of the 1/2/3/4 knobs.
- ⑭ **GANG status**
These show the GANG operation status of the 1/2/3/4 knobs.(see “Setting the GANG operation mode” on page 34)
: Set to GANG group 1
: Set to GANG group 2

Menu structure

The first time, press the **MENU** button to open the **INPUT** page of the menu. In the future, press this button to reopen the menu page that was last open.

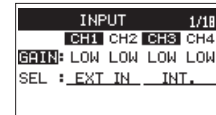

The Menu Screen has 18 pages organized by types of menu items.

	Page name	Meaning
1	INPUT	Make input settings.
2	MIXER	Make built-in mixer settings.
3	PHASE/DELAY	Make input phase settings and compensate for mic distances.
4	LEVEL CONTROL	Make input level settings.
5	TRIM GANG	Make GANG operation settings.
6	OUTPUT LEVEL	Make output level settings.
7	MIC POWER	Make mic power settings.
8	RECORD	Make recording channel settings.
9	REC SETTING	Make recording settings.
10	FILE	Make file settings.
11	MEDIA	Make media settings.
12	TIME CODE	Make time code settings.
13	SLATE TONE	Make slate tone settings.
14	HDMI AUDIO ASSIGN	Set HDMI output audio assignments.
15	METER/TRIM	Make meter and trim settings.
16	POWER MANAGEMENT	Make power management settings.
17	REMOTE	Make remote control settings.
18	SYSTEM	Make system settings.

2 – Names and functions of parts

The various menu items are as follows.

Menu item	Function	Page
INPUT page		
GAIN	Set the input gain.	page 20
SEL	Select input sources.	page 20
MIXER page		
LVL.	Adjust the level.	page 34
PAN	Adjust the left/right balance. Adjust the mid/side balance in mid-side mode.	
MS	Turn mid-side decoding on/off.	
PHASE/DELAY page		
PHAS	Set the input phase.	page 21
DELY	Compensate for mic distances.	page 21
LEVEL CONTROL page		
LIM.	Set the limiter.	page 23
AUTO	Set automatic level control.	page 24
LCF	Set the low-cut filter.	page 24
TRIM GANG page		
GRP1	Set the group 1 GANG operation.	page 34
GRP2	Set the group 2 GANG operation.	
OUTPUT LEVEL page		
CAMERA	Set the camera output level.	page 18
LINE	Set the line output level.	
MIC POWER page		
PHAN	Turn phantom power on/off.	page 22
VOLTAGE	Set the phantom power voltage.	page 22
PLUGIN	Set the plug-in power function.	page 23
RECORD page		
SEL	Make recording channel settings.	page 25
MIX	Make MIX recording settings.	page 25
DUAL	Make channel settings and adjust levels for dual recording.	page 26
REC SETTING page		
FILE TYPE	Set the recording file type.	page 24
FORMAT	Set the recording file format.	
SAMPLE	Set the sampling frequency.	

Menu item	Function	Page
FILE page		
NAME TYPE	Set the file name format.	page 36
WORD	Set the file name text.	
COUNT INIT	Reset the file number.	
MEDIA page		
BROWSE	Work with files and folders on the SD card.	page 31 page 32
NEW FOLDER	Make settings for new folder creation.	page 32
FORMAT	Format SD cards.	page 36
TIME CODE page		
SELECT	Set the time code source.	page 28
POWER OFF GEN	Set whether or not the generator runs when the power is off.	page 29
SLATE TONE page		
AUTO	Set the automatic slate tone.	page 27
VOLUME	Set the slate tone volume.	page 27
OSCILLATOR	Activate the oscillator.	page 27
HDMI AUDIO ASSIGN page		
SEL	Make HDMI output channel settings.	page 29
MIX	Make HDMI output MIX setting.	page 29
METER/TRIM page		
PEAK HOLD	Set the peak hold time.	page 37
TRIM MIN	Make the trim operation mute setting.	page 37
POWER MANAGEMENT page		
BATTERY TYPE	Set the type of batteries.	page 37
AUTO PWR SAVE	Set the automatic power off function.	page 37
BACKLIGHT	Set the time until the backlight turns off.	page 37
REMOTE page		
CONTROLLER	Make remote control settings.	page 39
MODE	Set the remote control mode.	
SYSTEM page		
INITIALIZE	Restore the default settings.	page 37
DATE/TIME	Set the date and time.	page 15
INFORMATION	Shows a variety of information.	page 38

CAUTION

- During recording, the menu pages from INPUT to OUTPUT LEVEL will be shown. The MIC POWER and later menu pages will not be shown.
- The settings for all menu items are retained even when the unit is turned off.

2 – Names and functions of parts

Basic Menu Screen operations

Use the following operations to work with the pages of the Menu Screen.

■ Selecting items (moving vertically on a page):

Turn the **DATA** dial.

NOTE

*Turn the **DATA** dial to move up or down one item at a time from the **INPUT** page **GAIN** item to the **SYSTEM** page **INFORMATION** item.*

■ Confirming a selected item:

Press the **DATA** dial.

■ Opening a submenu from a page:

Press the **DATA** dial.

■ Going back one level in a menu:

Press the **MENU** button.

■ Returning to the Home Screen from a menu:

Press the **MENU** button.

Menu operation procedures

In this example, we explain how to change recording settings.

1. Press the **MENU** button to open the Menu Screen.

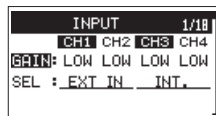

2. Turn the **DATA** dial to select an item (highlighted) to be set on a menu page.

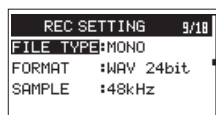

REC SETTING page FILE TYPE item selected

3. Press the **DATA** dial to move the cursor to (highlight) the value of the setting.

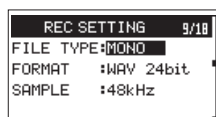

NOTE

*For a setting item that shows CH1/CH2/CH3/CH4, press the **DATA** dial to move the cursor to the setting value of the next channel in order. In addition, pressing a number button will also move the cursor to the corresponding channel.*

4. Turn the **DATA** dial to change the setting.
5. Press the **DATA** dial or **MENU** button to set a different item. This enables selection of a different item. Turn the **DATA** dial to select an item to be set.
6. Repeat steps 3 to 6 as necessary to set other items.
7. Press the **MENU** button to return to the Home Screen.

Basic operation

Use the following buttons to operate the various screens.

■ MENU button

This opens the Menu Screen.

■ 1/■ button

Press this to answer “NO” to a pop-up confirmation message.

■ DATA dial

Turn the **DATA** dial to select items and change values on setting screens. You can also turn the **DATA** dial to change the file playback position.

Push the **DATA** dial to confirm selections on setting screens and to answer “YES” to confirmation pop-up messages.

■ 3/▶▶ button

On the Browse Screen, use this to advance a level.

■ 4/◀◀ button

On the Browse Screen, use this to go back a level.

3 – Preparation

Powering the unit

Power sources

This unit can be powered by 4 AA batteries or by using the included USB cable to supply USB bus power. The USB cable can also be connected to a TASCAM PS-P515U AC adapter or a TASCAM BP-6AA external battery box (both sold separately). This unit can use alkaline, Ni-MH or lithium AA batteries.

Using AA batteries

Open the front cover and battery compartment. Install 4 AA batteries in the compartment with the ⊕ and ⊖ marks as shown. Then, close the battery compartment and front cover.

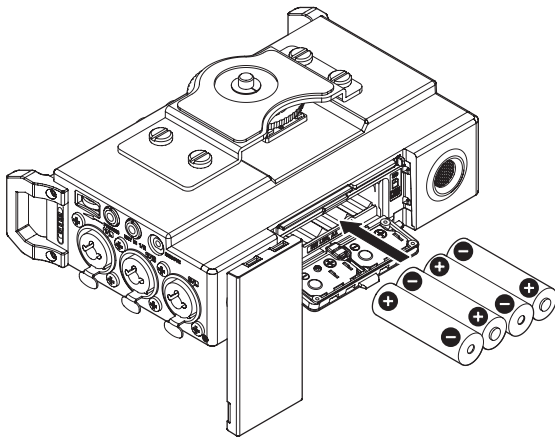

When using AA batteries, set the type of battery in order to accurately show the amount of power remaining and allow the unit to accurately determine whether power is available for proper operation. (see “Setting the type of batteries” on page 37)

CAUTION

- *Manganese dry cell batteries cannot be used with this unit.*
- *This unit cannot recharge Ni-MH batteries. Use a commercially available recharger.*

NOTE

A great amount of power is required to provide phantom power to a condenser microphone. If you use a condenser microphone while running the unit on AA batteries (alkaline, NiMH or lithium), the operation time will be shortened.

If you need to operate the unit for a long time, use a TASCAM PS-P515U AC adapter or TASCAM BP-6AA external battery box (both sold separately) to power the unit.

Using an AC adapter (sold separately)

Use the included USB cable to connect the TASCAM PS-P515U AC adapter to the unit's USB port as shown in the illustration.

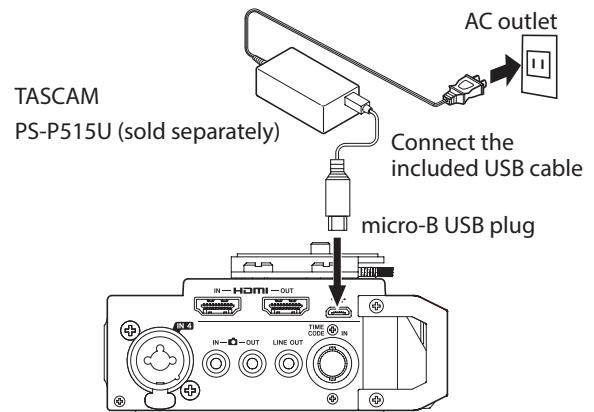

NOTE

When both batteries are installed and the AC adapter is connected, power will be supplied from the AC adapter.

CAUTION

- *Never use any adapter other than the designated TASCAM PS-P515U AC adapter. Use of a different adapter could cause malfunction, fire or electric shock.*
- *Noise may occur when recording with a microphone if the unit is too close to the AC adapter. In such a case, keep sufficient distance between the AC adapter and the unit.*

Using an external battery pack (sold separately)

Connect a TASCAM BP-6AA external battery pack (designed for use with this unit and sold separately) to the recorder with the included USB cable as shown in the illustration. For details, see the BP-6AA Owner's Manual.

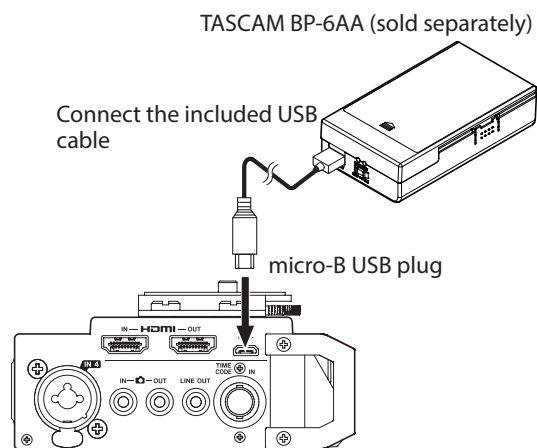

CAUTION

The unit cannot detect the remaining battery charge of a BP-6AA. If you use a BP-6AA to operate the recorder without batteries in the unit itself, it might stop operating suddenly if the battery pack runs out of charge.

In order to avoid problems, put batteries with sufficient charge into the unit before connecting and using a BP-6AA.

3 – Preparation

Using USB bus power

Connect the unit to a computer using the included USB cable as shown in the illustration.

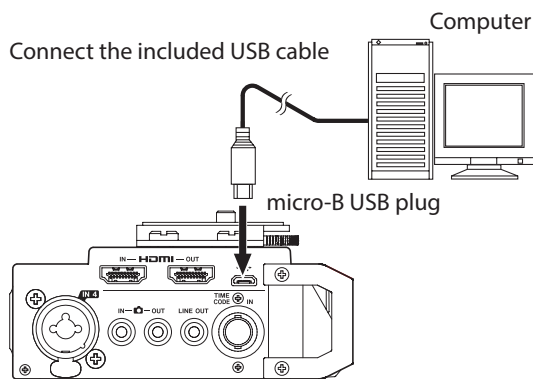

If the USB cable is connected while the unit is on or the unit is turned on with the USB cable already connected, the **USB SELECT** screen will appear. Choose between USB bus power supply or computer connection on this screen.



Turn the **DATA** dial to select **BUS POWER** and press the **DATA** dial to enable power supply from the USB port. The Home Screen will appear.

NOTE

Power is supplied from the USB port if the USB cable is connected to the unit even when it contains batteries (USB bus power prioritized).

CAUTION

- Depending on the USB bus power specifications of the computer, this unit might not function when connected to the computer by USB cable. In this case, use a TASCAM PS-P515U AC adapter (sold separately) or batteries.
- This unit does not support computer power conservation and sleep functions. When powering the unit using the USB bus power of a computer, always turn such functions off.

Turning the power on and off (putting it in standby)

CAUTION

- The unit enters standby mode if shut down when the unit is operating on AC power supplied through a TASCAM PS-P515U AC adapter (sold separately) or bus power supplied from a computer USB port.
- Turn down the volume of the monitoring system connected to the unit before turning the unit on/off (standby).
- Do not use headphones when turning the unit on/off (standby). Loud noises could damage the speakers or harm your hearing.

Turning the unit on

To start the unit when off (in standby), slide the **HOLD/⏻ / I** switch toward **⏻ / I** until "TASCAM DR-701D" (start-up screen) appears on the display.

The Home Screen appears after the unit starts up.



Start-up Screen



Home Screen

CAUTION

When the unit is started up for the first time (or when the built-in clock is reset after being left unused without batteries), the **DATE/TIME** screen appears before the Start-up Screen so you can set the date and time. (see "Setting the date and time" on page 15)

Turning the unit off (putting it in standby)

When on, slide the **HOLD/⏻ / I** switch toward **⏻ / I**.

The unit turns off (enters standby) after it completes its shutdown process.

CAUTION

Always use the **HOLD/⏻ / I** button to turn the unit off (put it in standby).

While the unit is on, do not remove the batteries, disconnect the power cord when using a TASCAM PS-P515U AC adapter (sold separately) or disconnect the USB cable when using USB bus power. Doing so will cause all recordings, settings and other data to be lost. Lost data and settings cannot be restored.

Resume function

This unit has a resume function. When started up, the unit locates to the position (time) where it was when turned off (put in standby) previously.

After the unit is turned on, playback is possible from the position (time) it was at when the **2/▶** button was pressed to turn the unit off (put it in standby).

NOTE

This data is stored on the SD card. The resume function will not work if the card is changed or formatted.

Setting the date and time

Using its internal clock, this unit includes the date and time when a file is recorded.

1. Select the **DATE/TIME** item on the **SYSTEM** page to open the **DATE/TIME** screen. (see “Menu operation procedures” on page 12)

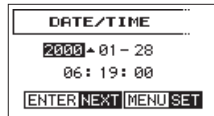

2. Turn the **DATA** dial to change a value, and press the **DATA** dial to confirm it and move the cursor to the next item. After you change the year, month, day, hour, minute and second in order, the cursor will return to the year.
3. Press the **MENU** button to confirm the change and return to the Menu Screen.

NOTE

You can set the unit to automatically add the date set here to file names. (see “Setting the file name format” on page 36)

Inserting and removing SD cards

Inserting the card

1. Open the front cover.
2. Insert an SD Card into the slot as shown in the illustration until it clicks into place.

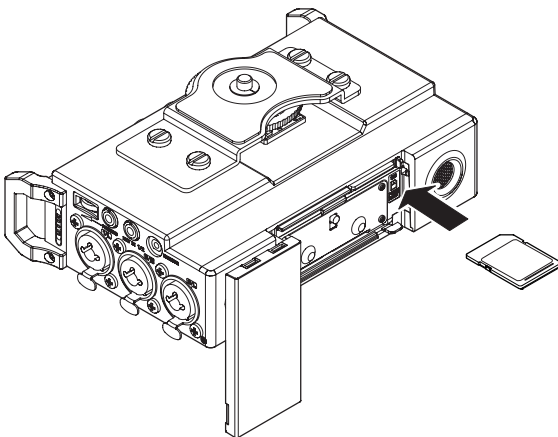

Removing the card

1. Open the front cover.
2. Press the SD card in gently and then release it to allow it to come out.

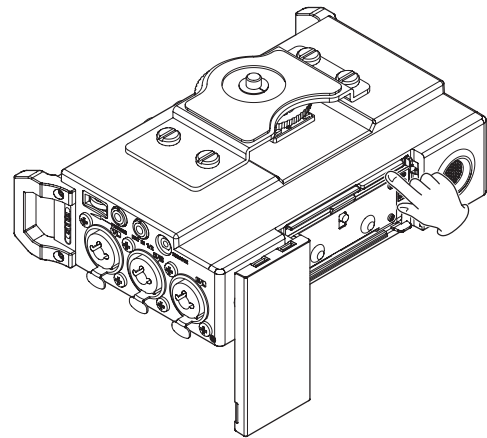

CAUTION

- Do not remove the SD card from the unit during recording, playback or at other times when it is being accessed.
- Do not remove the SD card from the unit when it is connected to a computer by USB.
- SD cards that meet SD, SDHC or SDXC standards can be used with this unit.
- A list of SD cards that have been confirmed to work with this unit can be found on the TEAC Global Site (<http://teac-global.com>).

SD card write protection switches

SD cards have protection switches that prevent writing new data to them.

If you slide the protect switch to the LOCK position, file recording and editing will not be possible. Move the switch to the unlocked position in order to record, erase and otherwise edit data on the card.

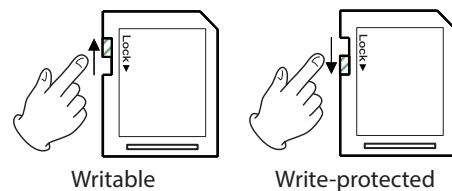

3 – Preparation

Preparing an SD card for use

In order to use an SD card in this unit, you must format it first.

1. Confirm that an SD card is installed and turn the power ON.
2. The following message appears when a new card or a card formatted for use with another device is installed in the unit.

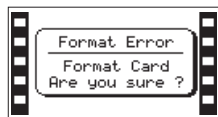

SD/SDHC card

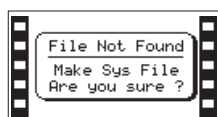

SDXC card

3. Press the **DATA** dial to start formatting.

CAUTION

Formatting a card erases all the data on it.

4. When formatting ends, the Home Screen opens. You can also reformat the card in this unit at any time.

CAUTION

When formatting a card, the unit should be operating on AC power supplied through the TASCAM PS-P515U adapter (sold separately), USB bus power supplied from a computer, or batteries with sufficient remaining power.

Camera connections

This unit and a camera can be connected in the following ways.

HDMI monitor

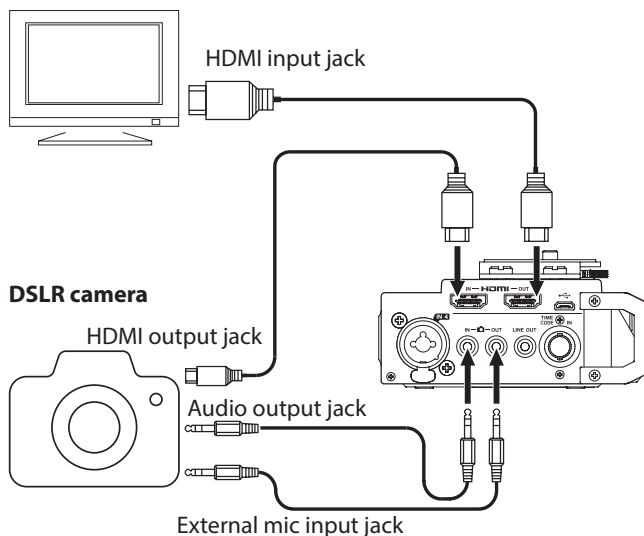

DSLR camera

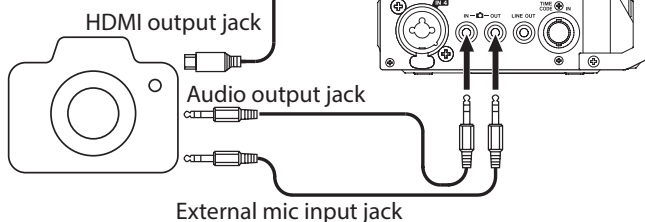

■ To record audio from this unit with a camera

Use a commercially-available 3.5mm stereo mini plug cable to connect the **OUT** jack on the right side of this unit with the external mic input on the camera.

■ To input audio from a camera and monitor it with headphones

Use a commercially-available 3.5mm stereo mini plug cable to connect the **IN** jack on the right side of this unit with the audio output on the camera.

■ HDMI connection to a camera

The unit can be synchronized with the camera's clock by connecting the camera's HDMI output to the unit's **HDMI IN** port. Moreover, HDMI time code can be received from the camera.

■ Connecting with an HDMI monitor/recorder

Video input from the camera by HDMI can have audio recorded by this unit added to it and then be output from the **HDMI OUT** port. The received HDMI time code can also be output.

NOTE

- Refer to the camera's operation manual to identify connectors on the camera.
- Use the **CAMERA** item on the **OUTPUT LEVEL** page to adjust the volume output to the camera. (see "Adjusting the playback volume" on page 18)
- To mount the camera on this unit, use the camera attachment screw on the top of the unit.

Setting the input functions

Recording with the built-in mics

Point the mics at the sound source and place the unit in a stable location where there is little vibration.

Connecting microphones

Connect microphones to this unit's **IN 1**, **IN 2**, **IN 3** and **IN 4** connectors.

Point the mics at the sound source and place the unit in a stable location where there is little vibration.

Connect an external stereo mic to the **EXT IN 1/2** jack on the left side of the unit.

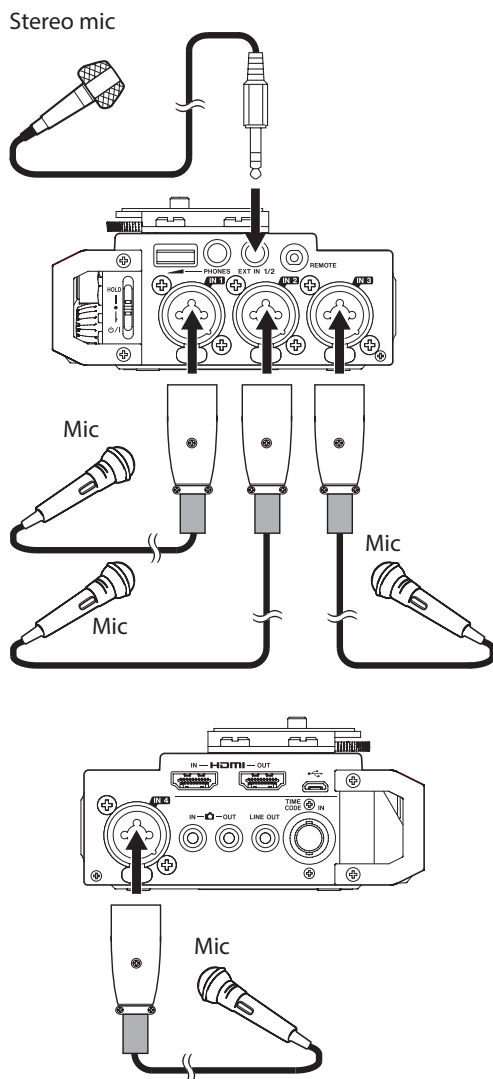

Recording an external device (LINE IN)

Use stereo plug cables to connect to the output of an external audio device.

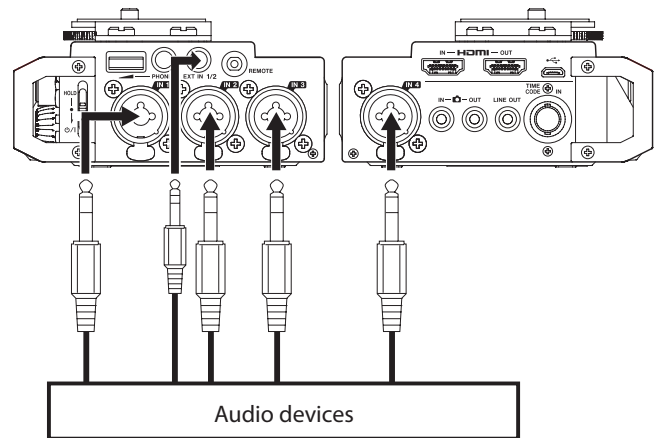

CAUTION

- Reduce the output level of the external audio device if the input sound is distorted even when reducing the input gain level on the unit.
- When an external audio device with a fixed line output level is connected, level overloads might occur and adjusting the gain level might not be possible because of loud sound sources, for example. In such cases, use the headphone jack or another level-controllable output for connection to the unit.

Connecting a time code generator

Use a BNC cable to connect a time code generator to this unit's **TIME CODE IN** connector.

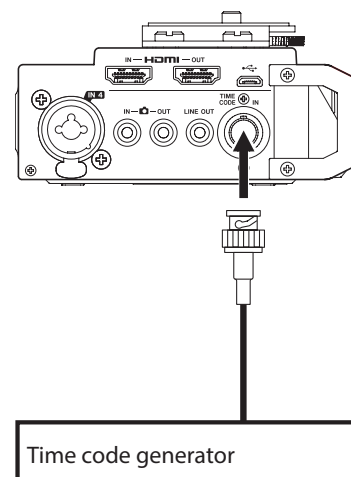

3 – Preparation

Connecting monitoring equipment

To listen with headphones, connect them to the **PHONES** jack.

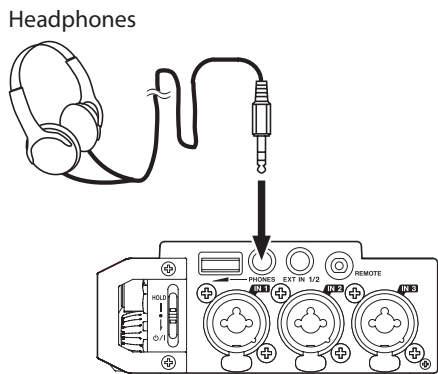

To listen with an external monitoring system (powered monitor speakers or an amplifier and speakers), connect it to the **LINE OUT** jack on the right side of the unit.

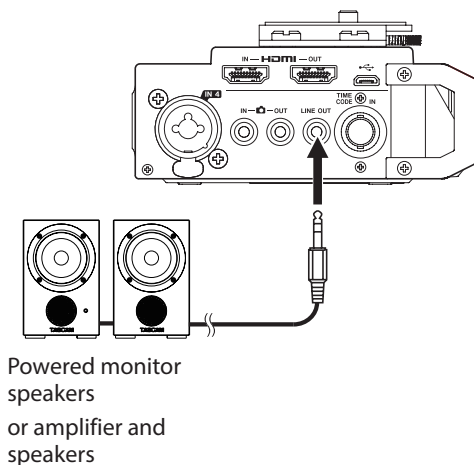

Powered monitor speakers or amplifier and speakers

Adjusting the playback volume

■ Adjusting the PHONES jack volume output

Use the **PHONES** volume control to adjust the volume output from the **PHONES** jack.

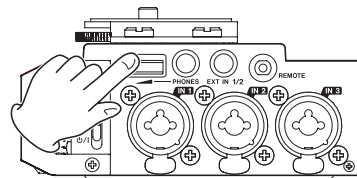

■ Adjusting the CAMERA OUT jack volume output

1. On the **OUTPUT LEVEL** page, select the **CAMERA** item. (see “Menu operation procedures” on page 12)

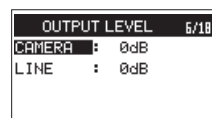

2. Set the volume output from the **CAMERA OUT** jack.
Range: -24dB – $+42\text{dB}$ (default: 0dB)
3. When finished, press the **MENU** button to return to the Home Screen.

CAUTION

*Hardware gain switching occurs at 3 points: between 0 dB and 1 dB, between 12 dB and 13 dB, and between 30 dB and 31 dB. A pop-up message will appear before gain switching. You can continue turning the **DATA** dial to change the setting, but a brief gap will occur in the output audio during gain switching.*

■ Adjusting the LINE OUT jack volume

1. On the **OUTPUT LEVEL** page, select the **LINE** item. (see “Menu operation procedures” on page 12)

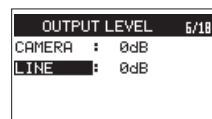

2. Set the volume output from the **LINE OUT** jack.
Range: -12dB – $+12\text{dB}$ (default: 0dB)
3. When finished, press the **MENU** button to return to the Home Screen.

CAUTION

*Hardware gain switching occurs between 0 dB and 1 dB. A pop-up message will appear before gain switching. You can continue turning the **DATA** dial to change the setting, but a brief gap will occur in the output audio during gain switching.*

Monitoring

You can monitor the input signals when the unit is stopped using headphones, for example.

Selecting the monitored signals

- When the Home Screen is open and the unit is stopped, paused, in recording standby or recording, press the **MONITOR** button to open the **MONITOR SELECT** screen where you can select which signals to monitor.

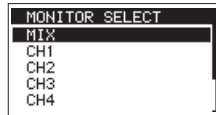

- Turn the **DATA** dial to select which signals to monitor.

Option	Meaning
MIX	Monitor a stereo mix.
CH1	Monitor the channel 1 input sound.
CH2	Monitor the channel 2 input sound.
CH3	Monitor the channel 3 input sound.
CH4	Monitor the channel 4 input sound.
CAMERA IN	Monitor the IN jack signal.
CH1-2	Monitor a mix of channels 1-2.
CH3-4	Monitor a mix of channels 3-4.
HDMI1*	Monitor the HDMI 1 input sound.
HDMI2*	Monitor the HDMI 2 input sound.
HDMI3*	Monitor the HDMI 3 input sound.
HDMI4*	Monitor the HDMI 4 input sound.
HDMI5*	Monitor the HDMI 5 input sound.
HDMI6*	Monitor the HDMI 6 input sound.
HDMI7*	Monitor the HDMI 7 input sound.
HDMI8*	Monitor the HDMI 8 input sound.
HDMI1-2*	Monitor a mix of HDMI 1-2.
HDMI3-4*	Monitor a mix of HDMI 3-4.
HDMI5-6*	Monitor a mix of HDMI 5-6.
HDMI7-8*	Monitor a mix of HDMI 7-8.

* The HDMI options appear when HDMI is synchronized.

NOTE

The monitoring options depend on the recording mode setting.

- When finished selecting the monitored signals, press the **DATA** dial or **MONITOR** button to return to the Home Screen.

NOTE

When CAMERA IN is selected, you can monitor the input sound through the PHONES jack, but the level meters will show the input sound according to the recording mode.

Using the accessory shoe on the top panel

To use the accessory shoe on the top panel, remove the DSLR attachment bracket.

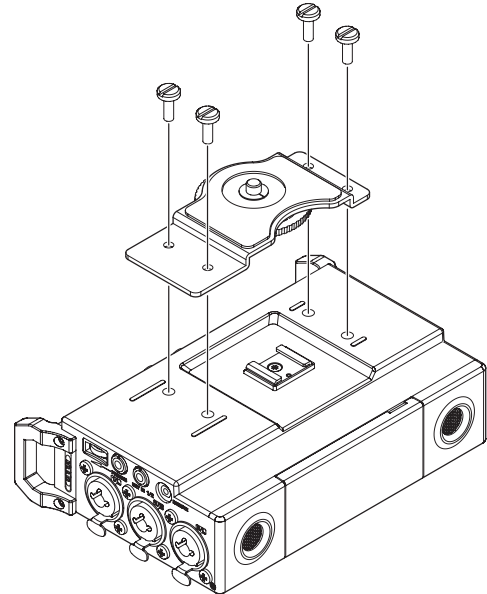

You can install the camera attachment bracket screw hole covers to the screw holes.

4 – Recording

In addition to using the built-in microphone, you can record using an external microphone or record the output signal from a mixer or other audio source.

The unit can be set to record audio files in WAV/BWF (44.1/48/96/192kHz, 16/24-bit) format.

Slate positions added to files when recording in Broadcast Wave Format (BWF) can be used as marks by software that supports this format. This recorder also includes dual recording, which allows the same input signals to be recorded at two different levels. It can also record 4 channels and a mix for a total of 6 files.

Setting where to save files

Set the folder where recorded files are saved.

Recorded files will be saved in the currently selected folder. For details, see the SELECT pop-up menu item under “Folder operations” on page 32.

If no setting is made, new files are created in the SOUND folder.

Setting the recording input sources

Use the SEL item on the INPUT page to set the recording input sources.

1. On the INPUT page, select the SEL item. (see “Menu operation procedures” on page 12)

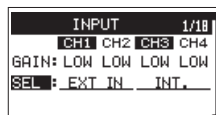

2. Select a recording channel and set its input source.

Channel	Option	Meaning
CH1/CH2	EXT IN (default)	Input from the EXT IN 1/2 jack.
	IN 1-2	Input from the IN 1 and IN 2 jacks.
CH3/CH4	INT. (default)	Input from built-in mics
	IN 3-4	Input from the IN 3 and IN 4 jacks.

3. When finished, press the MENU button to return to the Home Screen.

Adjusting the input level

Before starting recording, input levels should be adjusted to prevent recorded sounds or signals from being distorted due to excessive input levels and to prevent them from being so low that they are below the noise floor.

In addition to manual adjustment, the unit has limiter and automatic level control functions that can be used as required. (see “Using the limiter” on page 23) and (see “Setting automatic level control (ALC)” on page 24).

TIP

In addition to adjusting input levels, try changing the distances and angles between the microphones and the sound sources. The angles and distances of the microphones can also change the character of the recorded sound.

1. On the INPUT page, select the GAIN item. (see “Menu operation procedures” on page 12)

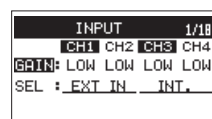

2. Select a channel to set its input gain.

Option	Meaning
LINE	Use when connecting the line output jacks of external devices to this unit's IN 1, IN 2, IN 3 and IN 4 connectors.
LOW (default)	Use when connecting mics to this unit's IN 1, IN 2, IN 3 and IN 4 connectors.
MID	
HI	
HI+	

NOTE

- LINE cannot be selected when the SEL item on the INPUT page is set to EXT IN or INT. (see “Setting the recording input sources” on page 20)
- The LOW, MID, HI and HI+ settings have different input gains. Choose the setting according to the input level. If you are not sure which setting to use, try LOW first. If the input level is too low even after adjustment, return to this screen and set it to MID. If the level is still too low, set it to HI or HI+ and make adjustments.

CAUTION

Depending on this setting, the input level setting range changes. For this reason, the input level might change greatly when this setting is changed. Before changing it, turn the output level all the way down.

3. When finished, press the MENU button to return to the Home Screen.

- Turn the **DATA** dial to switch the Home Screen to trim display mode.

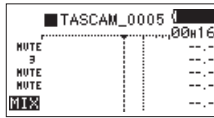

- Use the **1, 2, 3** and **4** knobs to adjust the input levels.

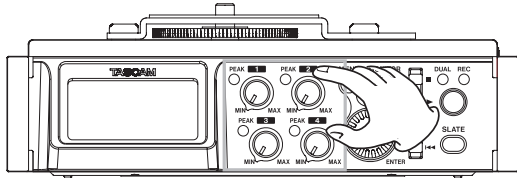

If input levels are too high, the **PEAK** indicators to the left of the knobs light red.

The dotted lines at the -20dB (▼ mark) and -12dB positions are guides for input level adjustment.

Levels should fluctuate around -20 dB and reach their maximums around -12 dB .

Since the sound will distort if the **1/2/3/4** knob **PEAK** indicators light, set the input levels so they do not light.

CAUTION

During mic input, these also light if distortion occurs in the analog circuitry.

During line level input, these do not light even if distortion occurs in the analog circuitry.

NOTE

*To monitor the sound while adjusting the input levels or recording, connect headphones to the **PHONES** jack.*

*Use the **PHONES** jack volume control to adjust the monitoring level.*

Compensating for mic distances

Use this function to compensate for delays that result from differences in distances between the built-in mics and external mics as well as between external mics.

- On the **PHASE/DELAY** page, select the **DEL** item.(see “Menu operation procedures” on page 12)

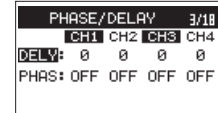

- Select a channel and set its value according to the distance of the connected mic.

Range: 0 (default) – 300 (ms)

- When finished, press the **MENU** button to return to the Home Screen.

Setting phase reversal for individual channels

Input phase reversal can be set.

- On the **PHASE/DELAY** page, select the **PHAS** item.(see “Menu operation procedures” on page 12)

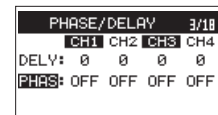

- Select a channel and set its phase.

Options: **OFF** (default, normal phase), **ON** (reversed phase)

- When finished, press the **MENU** button to return to the Home Screen.

4 – Recording

Set the power sources used by mics

Setting phantom power

Phantom power can be turned on when an external mic that requires it is connected to an **IN 1/IN 2/IN 3/IN 4** jack.

1. On the **MIC POWER** page, select the **PHAN** item. (see “Menu operation procedures” on page 12)

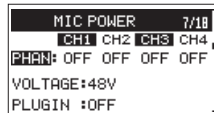

2. Select a channel that requires phantom power and turn phantom power on/off.
Options: **ON** (default), **OFF**
3. When finished, press the **MENU** button to return to the Home Screen.

When stopped, if you set the **PHAN** item on the **MIC POWER** page to **ON**, a pop-up message appears confirming that you want to turn phantom power on (as long as the **SEL** item on the **INPUT** page for the selected channel is set to **IN 1-2** or **IN 3-4**).



When the confirmation pop-up message opens, press the **DATA** dial to turn phantom power on for the **IN 1/IN 2/IN 3/IN 4** jack and supply phantom power (24V or 48V) to the connected mic.

Use the **MIC POWER** page to set the voltage to 24V or 48V. (see “Setting the phantom power voltage” on page 22)

NOTE

- When the **GAIN** item is set to **LINE** or the **SEL** item is set to **EXT IN** or **INT** on the **INPUT** page, phantom power will not be output even if the **PHAN** item is set to **ON**, so the pop-up message will not appear.
- Battery power will be consumed faster when set to 48V than when set to 24V.

CAUTION

- Confirm that phantom power is OFF before connecting a line level device to an IN 1, IN 2, IN 3 or IN 4 connector. If you connect a line level device while phantom power is being supplied, that device and this unit could be damaged.
- When using a condenser microphone, before connecting to or disconnecting from an **IN 1, IN 2, IN 3** or **IN 4** connector, confirm that the phantom power for that jack is **OFF**. If you connect or disconnect a mic while phantom power is being supplied, that mic and this unit could be damaged.
- Turn phantom power **ON** only when using a condenser microphone that requires phantom power. Turning phantom power on when a dynamic mic or other mic that does not require it is connected could damage this unit and connected equipment.
- When using condenser mics that require phantom power and dynamic mics together, be sure to use balanced dynamic mics. Unbalanced dynamic mics cannot be used when phantom power is enabled.
- Supplying phantom power to some ribbon mics will break them. If you are unsure, do not supply phantom power to a ribbon mic.
- When using USB bus power, the unit might not be able to supply phantom power depending on the computer. In this case, use a TASCAM PS-P515U AC adapter (sold separately).
- Some condenser microphones will not operate when phantom power is set to 24V.
- Do not connect or disconnect the AC adapter when using phantom power. The unit could turn off even when batteries are installed, resulting in recorded data becoming damaged or lost.

Setting the phantom power voltage

Use the **VOLTAGE** item on the **MIC POWER** page to set the supplied power voltage used when an external mic that requires phantom power is connected.

1. On the **MIC POWER** page, select the **VOLTAGE** item. (see “Menu operation procedures” on page 12)

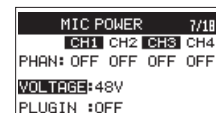

2. Set the supplied phantom power voltage.
Options: 24V, 48V (default)

NOTE

- Battery power will be consumed faster when set to 48V than when set to 24V.
3. When finished, press the **MENU** button to return to the Home Screen.

Setting plug-in power

The plug-in power function can be turned on when an external mic that uses it is connected to the **EXT IN 1/2** jack.

1. On the **MIC POWER** page, select the **PLUGIN** item. (see “Menu operation procedures” on page 12)

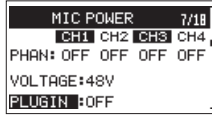

2. Turn plug-in power on or off.
Options: OFF (default), ON
3. When finished, press the **MENU** button to return to the Home Screen.

CAUTION

- *When connecting a dynamic mic or external mic that has its own battery, do not turn plug-in power on. If plug-in power is on, it could damage the connected mic.*
- *Use headphones to monitor when you are recording with a microphone. If you use speakers for monitoring, the sound output from the speakers could be picked up by the mic, resulting in its unwanted recording or feedback noise.*

Using the limiter

When the limiter is on, the input gain will be adjusted automatically according to the input level to set the recording level so that distortion does not occur even when loud sounds are input.

1. Select the **LIM.** item on the **LEVEL CONTROL** page. (see “Menu operation procedures” on page 12)

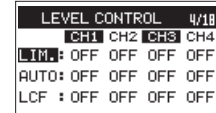

2. Select a channel and set the limiter function for it.

Option	Meaning
OFF (default value)	Limiter off
ON	Limiter on only for selected channel
3B	Multiband limiter* on only for selected channel
LINK	Linked with selected channel
3BAND	Multiband limiter* on for both selected and linked channels

* 3-band (high/mid/low) limiter

3. When finished, press the **MENU** button to return to the Home Screen.

CAUTION

Distortion might occur if the input sound is too loud even when the limiter is on. In such a case, lower the input level or increase the distance between the unit and the sound source.

NOTE

- *The multiband limiter can only be turned on if the sampling frequency is 44.1/48kHz.*
- *When set to ON or 3B, the limiter only affects the channel that has excessive input. When set to LINK or 3BAND, the limiter affects channels that have excessive input and the channels linked to them.*

4 – Recording

Setting automatic level control (ALC)

You can set the automatic level control (ALC) used during microphone input.

When ALC is on, the input level will be adjusted automatically in response to the input audio.

Using this function, the recording level is automatically increased when the input sound is too quiet or decreased when it is too loud. This function is useful for recording meetings, for example. In this mode, the recording level cannot be changed manually.

1. Select the **AUTO** item on the **LEVEL CONTROL** page. (see “Menu operation procedures” on page 12)

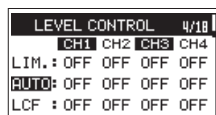

2. Select a channel and turn the automatic level control function on or off for it.
Options: OFF (default), ON
3. When finished, press the **MENU** button to return to the Home Screen.

Setting the low-cut filter

The low-cut filter can reduce bothersome noise, such as from wind, air-conditioners and projectors.

1. Select the **LCF** item on the **LEVEL CONTROL** page. (see “Menu operation procedures” on page 12)

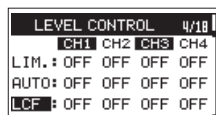

2. Select a channel and set the low-cut filter cut-off frequency for it.
Options: OFF (default), 50 (Hz), 80 (Hz), 120 (Hz), 180 (Hz), 220 (Hz)
3. When finished, press the **MENU** button to return to the Home Screen.

Setting the recording file type, file format and sampling frequency

Use the items on the **REC SETTING** page to set the recorded audio file format before you start recording. (see “Menu operation procedures” on page 12)

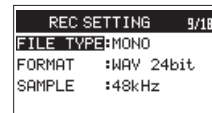

■ Setting the recording file type

Select the **FILE TYPE** item and set the recording file type.

Option	Meaning
MONO (default)	The channels selected for recording will be recorded as mono files. A file will be made for each channel selected for recording.
STEREO	Stereo files will be recorded. For example, if only channel 1 is selected for recording, a stereo file with channel 2 silent will be created. If only channels 1 and 3 are selected for recording, stereo files with channels 2 and 4 silent will be created.
6ch	Channels 1–4 and a MIX will be recorded as a single file.

■ Setting the file format

Select the **FORMAT** item and set the file format.

Options: BWF 16bit, BWF 24bit (default), WAV 16bit, WAV 24bit

NOTE

BWF is a format created for broadcasting that has the same sound quality as the standard WAV format. It also uses the same “.wav” file extension as WAV files. In this manual, we distinguish these file types by using the terms BWF and WAV.

■ Setting the sampling frequency

Select the **SAMPLE** item and set the sampling frequency.

Options: 44.1kHz, 48kHz (default), 96kHz, 192kHz

Setting channels to record

When shipped new from the factory, all channels are set to record. To turn recording off for a channel, set the **SEL** item on the **RECORD** page to **OFF**.

1. On the **RECORD** page, select the **SEL** item. (see “Menu operation procedures” on page 12)

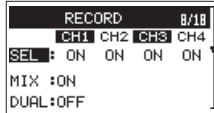

2. Select a recording channel and turn it on or off.
Options: **ON** (default), **OFF**
3. When finished, press the **MENU** button to return to the Home Screen.

Make MIX channel recording settings

When shipped new from the factory, the **MIX** item for the MIX channel recording setting is set to **ON**. To turn recording off for the MIX channel, set the **MIX** item on the **RECORD** page to **OFF**.

1. On the **RECORD** page, select the **MIX** item. (see “Menu operation procedures” on page 12)

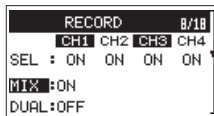

2. Turn the MIX channel recording on or off.
Options: **ON** (default), **OFF**
3. When finished, press the **MENU** button to return to the Home Screen.

When the MIX channel recording setting is **OFF**, the input will be muted for any channel (1, 2, 3 or 4) that also has its recording setting **OFF**.

Recording (MONO/STEREO/POLY (6ch))

Starting recording

1. Press the record (●) button. This starts ordinary recording.



When recording starts, the **REC** indicator lights continuously, and the display shows the elapsed recording time and the remaining recording time.

2. Press the **1/■** button to stop recording.

File names when the FILE TYPE is MONO

One file will be created for each channel.

The files will be named in the following manner.

TASCAM_0001_1.WAV
① ② ③

- ① Set with the **WORD** item on the **FILE** screen
- ② Recording file project number
- ③ Assigned channel

File names when the FILE TYPE is STEREO

A separate file will be created for channels 1/2, 3/4 and the MIX channel.

The files will be named in the following manner.

TASCAM_0002_12.WAV
① ② ③

- ① Set with the **WORD** item on the **FILE** screen
- ② Recording file project number
- ③ Assigned channel

File names when POLY (6ch) recording

A single file will be created for all channels (1, 2, 3, 4 and MIX).

The files will be named in the following manner.

TASCAM_0002_6CH.WAV
① ② ③

- ① Set with the **WORD** item on the **FILE** screen
- ② Recording file project number
- ③ Assigned channel

4 – Recording

Creating a new file while continuing to record (file incrementing)

During recording, the unit can create a new file while continuing to record (file incrementing). You can do this manually or the unit can do it automatically when the file size reaches 2 GB.

Manually incrementing files during recording

During recording, you can easily create a new file while continuing to record at any time.

1. Press the **3/▶▶** button while recording.

NOTE

When new files are created, incremental numbers are added to the end of each file name.

CAUTION

- A new file cannot be created if the total number of folders and files would exceed 5000.
- If the name of a file to be created would be the same as that of an existing file, the number will be incremented until the new file has a unique name.

Automatically incrementing files during recording

Without pausing recording, a new file can be created automatically during recording when the file size reaches 2 GB.

CAUTION

A new file cannot be created if the total number of folders and files would exceed 5000.

Simultaneously recording two files at different input levels (DUAL REC)

This recorder can simultaneously record a second recording at a different input level along with the regular recording. For example, when recording with microphones, you can make an ordinary recording with the input level set as high as possible and simultaneously record at a slightly lower input level for safety.

Two recorded files (one with higher input level and one with lower input level) are saved individually.

NOTE

Make the input level setting for the ordinary recording in the usual manner. (see “Adjusting the input level” on page 20).

Enabling dual recording

1. On the **RECORD** page, select the **DUAL** item. (see “Menu operation procedures” on page 12)

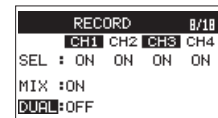

2. Set the dual recording channels.

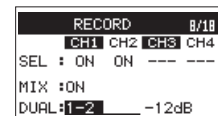

Options: OFF (default), 1-2, 3-4

3. Set the input level of the other dual recording.
Options: -1 dB – -12 dB (default, in 1 dB increments)

NOTE

This setting is not possible if 3 or more channels or channels that do not make a stereo pair, such as 1 and 3, are set to record.

4. When finished, press the **MENU** button to return to the Home Screen.

Starting dual recording

Press the record (●) button to start dual recording.

During dual recording, the recording screen appears as follows.



In the input source display area of the recording screen, the input levels of the current input source and the dual recording are shown.

Dual recording file names

Dual recording will create two files simultaneously.

The name of the second file created by dual recording has “-XX” added to the file name of the ordinary recording.

“-XX” shows the amount that the input level has been lowered.

TASCAM_0003_12.WAV

① ② ③

TASCAM_0003_D12-05.WAV

① ② ④ ③ ⑤

- ①: Set with the **WORD** item on the **FILE** page
- ②: Recording file project number
- ③: Assigned channels (“12” is channel 1/2 and “34” is channels 3/4)
- ④: “D” indicates the file with the lowered level during dual recording
- ⑤: Dual recording file recorded with input level set to -5dB (this would be “-06” if recorded at -6dB or “-10” if recorded at -10dB, for example.)

Using mark functions

Adding marks manually to a recording

During recording or when recording is paused, press the **DATA** dial to add a mark at that point manually.

The number of the added mark appears in a pop-up on the display.



NOTE

- The maximum number of marks that can be added to each file is 99. The mark data is stored in the file.
- Marks added to BWF format WAV files by this unit during recording are stored in the file. These marks can be used when playing back the file using software or equipment that supports the BWF format.

Moving to a mark position

When stopped or during playback, press the **◀◀** or **▶▶** button to move between marks in the selected file.

You can use this function to identify points to create shortcuts to the beginning of songs, for example.

NOTE

You cannot move to a mark in a different file.

Using the auto tone function

The auto tone function can be used to automatically insert a tone signal whenever recording starts and stops.

By connecting the **OUT** jack on the right side of the unit to the audio input jack of a camera, both units can record the same tone signals to their files. These tones can be used as guides to synchronize the files in video editing software.

For details about how to connect the unit with a DSLR camera, see “Camera connections” on page 16.

Setting the auto tone function

1. Select the **AUTO** item on the **SLATE TONE** page. (see “Menu operation procedures” on page 12)

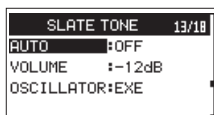

2. Set where tone signals are inserted.
Options: **OFF** (default), **HEAD** (recording start only), **HEAD+TAIL** (recording start and stop)
3. When finished, press the **MENU** button to return to the Home Screen.

Setting the volume of auto tones and slate tones

You can adjust the volume of the auto tones and slate tones.

1. Select the **VOLUME** item on the **SLATE TONE** page. (see “Menu operation procedures” on page 12)

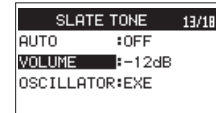

2. Set the tone volume.
Options: **-36dB**, **-30dB**, **-24dB**, **-18dB**, **-12dB** (default)
3. When finished, press the **MENU** button to return to the Home Screen.

Using the oscillator

You can use the oscillator to adjust the levels of this unit and connected devices.

1. Select the **OSCILLATOR** item on the **SLATE TONE** page. (see “Menu operation procedures” on page 12)

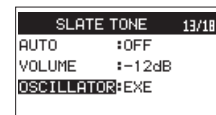

2. Press the **DATA** dial.
A setting pop-up message appears.



3. Set the level of the signal output.
Options: **-20dB** (default), **-18dB**
4. When finished making the setting, press the **1/■** button to stop signal output.

4 – Recording

Recording slate tones

During recording, playback or monitoring, press the **SLATE** button on the back of the unit to output a slate tone at the point you want.

During recording, inserted slate tones can be added to files.

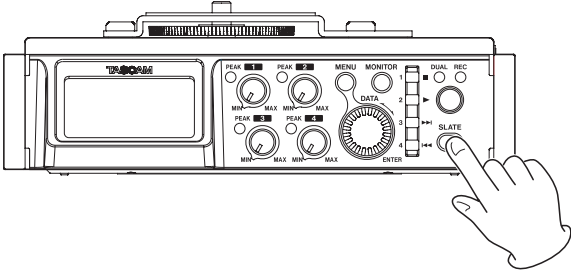

For details about how to connect the unit with a DSLR camera, see “Camera connections” on page 16.

NOTE

*In order to prevent misoperation, the **SLATE** button must be held briefly to insert a slate tone.*

*Slate tones are output from the **LINE OUT** and **OUT** jacks.*

Moving to slate tone insertion positions

NOTE

Marks are added at slate tone insertion positions. For details about how to locate to marks, see “Moving to a mark position” on page 27.

Inputting time code and adding recording start times to files

Setting the time code source input

This sets the source of input time code.

1. On the **TIME CODE** page, select the **SELECT** item. (see “Menu operation procedures” on page 12)

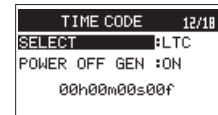

2. Set the time code input source.

Option	Meaning
LTC (default)	Time code is input through the TIME CODE IN connector. The unit synchronizes to time code when it is being input. If time code input stops, the unit runs by itself. If the input resumes, the unit synchronizes with that input.
HDMI	Time code is input through the HDMI IN port, and the unit synchronizes with the input time code. The unit stops time code if HDMI is disconnected.
RTC	Time code is generated from the time of the unit's built-in clock. When the unit is turned on, this mode is activated or the built-in clock is reset, the unit captures the time from the built-in clock and runs by itself.

3. When finished, press the **MENU** button to return to the Home Screen.

Setting the power off generator function

You can set whether or not the time code generator continues to run if the power is turned off while the time code generator is running.

1. On the **TIME CODE** page, select the **POWER OFF GEN** item. (see “Menu operation procedures” on page 12)

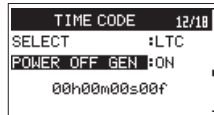

2. Set whether or not the generator runs when the power is off.

Option	Meaning
ON (default)	Set the time code generator to continue running if the unit is turned off while it is running.
OFF	Set the time code generator to stop running if the unit is turned off while it is running.

NOTE

- This setting is only valid when the time code source is **LTC**.
- Since time code will continue to advance when the power generator function is **ON**, the time code generator will start at the time corresponding to when the unit is turned on again.

For this reason, capturing time code again and other operations are not necessary. However, this function interpolates based on the built-in clock, so a small error could occur in the restarted time code value when the unit is turned on again. The built-in clock, though, is constantly calibrated using a high-precision TCXO, so its error is less than 2 ppm.

3. When finished, press the **MENU** button to return to the Home Screen.

Example 1: master time code is continuous

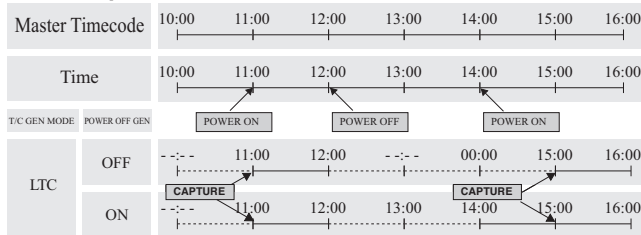

Example 2: master time code is not continuous

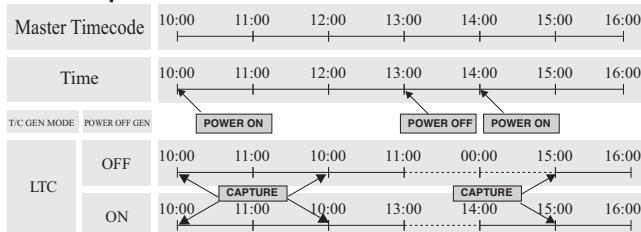

CAPTURE

Master time code is input through this unit's time code input connector and recognized by the unit.

Checking the time code counter

On the **TIME CODE** page, the time code generator time is shown below the **POWER OFF GEN** item (in hours, minutes, seconds and frames).

Outputting this unit's audio as the HDMI output audio

Outputting the audio of each input channel from the HDMI output

You can replace the HDMI output audio with this unit's input audio. HDMI audio has 8 channels. You can replace 2 channels at a time with this unit's input audio.

1. On the **HDMI AUDIO ASSIGN** page, select the **SEL** item. (see “Menu operation procedures” on page 12)

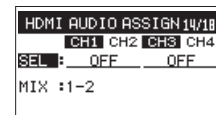

2. Select an input channel and set which HDMI audio channels they will replace.
Options: **OFF** (default), 1-2, 3-4, 5-6, 7-8
3. When finished, press the **MENU** button to return to the Home Screen.

Outputting the MIX audio from the HDMI output

1. On the **HDMI AUDIO ASSIGN** page, select the **MIX** item. (see “Menu operation procedures” on page 12)

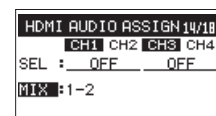

2. Set which HDMI audio channels the **MIX** audio will replace.
Options: **OFF**, 1-2 (default), 3-4, 5-6, 7-8
3. When finished, press the **MENU** button to return to the Home Screen.

NOTE

- When set to the default **OFF**, HDMI input audio will be output as is.
- Settings cannot overlap.

4 – Recording

Recording duration

The table below shows maximum recording times by file format on SD/SDHC/SDXC cards of different capacities (in hours and minutes).

File format (recording setting)		SD/SDHC/SDXC card capacity		
		8 GB	32 GB	128 GB
WAV/BWF 16-bit (2-channel)	44.1 kHz	12:35	50:23	201:35
	48 kHz	11:34	46:17	185:13
	96 kHz	5:47	23:08	92:36
	192 kHz	2:53	11:34	46:18
WAV/BWF 24-bit (2-channel)	44.1 kHz	8:23	33:35	134:24
	48 kHz	7:42	30:51	123:28
	96 kHz	3:51	15:25	61:44
	192 kHz	1:55	7:42	30:52

- The recording times shown above are estimates. They might differ depending on the SD/SDHC/SDXC card in use.
- The recording times shown above are not continuous recording times, but rather they are the total possible recording times for the SD/SDHC/SDXC card.
- If recording in mono (1 channel), maximum recording times will be about double those above.
- If recording with 4 channels, maximum recording times will be about half those above.

5 – Working with Files and Folders (Browse Screen)

On the Browse Screen, you can view the contents of the SOUND folder, which contains the audio files, on the SD card.

TIP

If you connect the unit with a computer by USB, or mount the SD card on a computer using a card reader or other input, you can use the computer to change the folder structure within the SOUND folder and erase files.

To open the Browse Screen, select the BROWSE item on the MEDIA page, and press the DATA dial. (see “Menu operation procedures” on page 12)

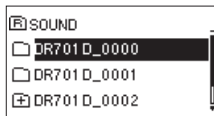

The contents of the folder that contains the file that was selected on the Home Screen before the Browse Screen was opened appears on the display.

Navigating the Browse Screen

On the Browse Screen, folders and audio files appear in lists in the same way files are shown on a computer.

Folders can only be made to two levels.

- Turn the DATA dial to select files and folders.
- When a folder is selected, press the 3/▶▶ button to show the contents of that folder.
- When a file or folder is selected, press the 4/◀◀ button to exit the currently open folder and go to a higher level in the folder structure.
- When a file or folder is selected, press the DATA dial to open the pop-up menu.
- When a file is selected, press the 2/▶ button to return to the Home Screen and play that file.

The folder that contains this file becomes the current folder, and new recorded files will be saved in this folder. This folder also becomes the playback area.

- When a file is selected, press the 3/▶▶ button to return to the Home Screen and load that file.

The folder that contains this file becomes the current folder, and new recorded files will be saved in this folder. This folder also becomes the playback area.

- When a folder is selected, press the 2/▶ button to return to the Home Screen. The first file in the folder (shown at the top of the file list) will be played.

This folder becomes the current folder, and new recorded files will be saved in this folder. This folder also becomes the playback area.

Icons on the Browse Screen

The meanings of icons that appear on the Browse Screen are as follows.

■ SOUND folder

The SOUND Folder is the highest (root) level folder in the hierarchy shown on the Browse Screen.

■ Audio file

This icon appears before the names of music files.

■ Folder

This icon shows folders that contain subfolders.

■ Folder

This icon shows folders that do not contain subfolders.

■ Open folder

The contents of the folder marked with this icon currently appear on the display.

■ New folder

Create a new folder.

File operations

Select the desired audio file on the Browse Screen and press the DATA dial to open the pop-up menu shown below.

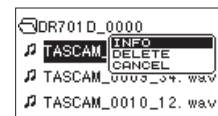

Turn the DATA dial to select the desired operation, and press the DATA dial to execute it as follows.

■ INFO

Information (date/time, size) about the selected file appears.

Press the DATA dial again or press the 1/■ button to return to the Browse Screen.

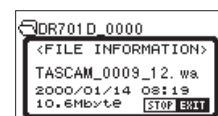

■ DELETE

A message appears to confirm that you want to delete the file.

Press the DATA dial to erase the files or the 1/■ button to cancel deletion.

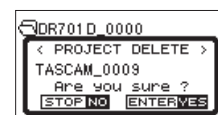

CAUTION

Files with the same basic number, including the currently selected file, will be deleted at the same time.

■ CANCEL

This cancels the operation for the selected (highlighted) file and closes the pop-up menu.

5 – Working with Files and Folders (Browse Screen)

Folder operations

Select the desired folder on the Browse Screen and press the **DATA** dial to open the pop-up menu shown below.

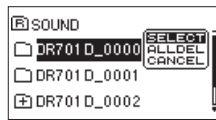

Turn the **DATA** dial to select the desired operation, and press the **DATA** dial to execute it as follows.

■ SELECT

This selects the first file in the folder and returns to the Home Screen. This folder becomes the playback area. When recording, files are also created in this folder.

■ ALLDEL

A pop-up message appears to confirm that you want to delete all the files in the selected folder at once.

Press the **DATA** dial to erase the files or the **1/■** button to cancel deletion.



NOTE

You cannot erase read-only files and files that are not recognized by this unit.

■ CANCEL

This cancels the operation for the selected (highlighted) folder and closes the pop-up menu.

Creating a new folder

Using the MEDIA menu page to create a folder

1. On the **MEDIA** page, select the **NEW FOLDER** item. (see "Menu operation procedures" on page 12)

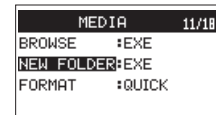

2. Press the **DATA** dial.

A pop-up appears to confirm that you want to create a new folder.



3. Press the **DATA** dial to create the new folder.
Press the **1/■** button to cancel folder creation.

Using NEW FOLDER on the Browse Screen

1. Select **NEW FOLDER** at the bottom of the folder list.

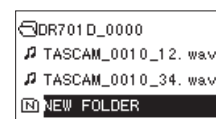

2. Press the **DATA** dial.

A pop-up appears to confirm that you want to create a new folder.



3. Press the **DATA** dial to create the new folder.
Press the **1/■** button to cancel folder creation.

NOTE

*Since the unit supports only a two-level folder structure, **NEW FOLDER** does not appear in second-level folders. A newly created folder becomes the current one, and new recorded files are saved in this folder. This folder also becomes the playback area.*

Playing recordings

When the Home Screen is open and playback is stopped, press the **2/▶** button to start playback.

NOTE

You can also choose files for playback by name on the Browse Screen.

Pausing playback

When the Home Screen is open and a file is playing back, press the **2/▶** button to pause playback at the current position.

Press the **2/▶** button again to restart playback from that position.

Stopping playback

When the Home Screen is open and a file is playing back, press the **1/■** button to stop playback and return to the beginning of the file.

Searching backward and forward

When the Home Screen is open and a file is playing back or stopped, press and hold the **4/◀◀** or **3/▶▶** button to search backward or forward.

NOTE

*Press and hold the **4/◀◀** or **3/▶▶** button to accelerate the search speed.*

Jumping between playback positions

When the Home Screen is open, use the **4/◀◀** and **3/▶▶** buttons to jump to the nearest mark in that direction.

Press the **4/◀◀** button when the current playback position is before the first mark to jump to the beginning of the file.

Press the **4/◀◀** button when located at the beginning of a file to jump to the beginning of the previous file.

Press the **3/▶▶** button when the current playback position is after the last mark to jump to the beginning of the next file.

NOTE

- *The file name, file number and other file information for the currently playing file appear on the display.*
- *The ■ icon appears on the display when playback is stopped at the beginning of a file. The ■■ icon appears when playback is paused in the middle of a file.*
- *Press the **4/◀◀** and **3/▶▶** buttons repeatedly if you want to move between files.*

Playing dual recording files

Files created by dual recording are added after the file created at the normal level.

Play the file recorded at the normal level, and press the **3/▶▶** button to play the file recorded at the lower input level.

7 – Mixer

This unit has mixer functions that allow panning and volume levels to be set for each channel.

Setting the mixer

1. On the **MIXER** page, select the **LVL** or **PAN** item. (see “Menu operation procedures” on page 12)

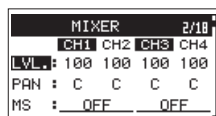

2. Select the item that you want to change and adjust the value.

Item	Option	Function
LVL	0-100	Adjusts the volume level. (minimum at 0, maximum at 100)
PAN	L12-C-R12	Adjust the left/right balance. (far left at L12, centered at C, far right at R12)

3. When finished, press the **MENU** button to return to the Home Screen.

NOTE

- These can be adjusted at any time (when stopped, paused, playing, recording or in recording standby).
- When recording, the **MS** item cannot be changed.

Using mid-side microphones

This unit includes a mid-side decoder that allows recording with mid-side mics and playback of files recorded with them.

1. Connect a mid-side mic to the **IN 1** and **IN 2** jacks or the **IN 3** and **IN 4** jacks.

Connect the mid-side mic mid to the **IN 1** or **IN 3** jack and the side to the **IN 2** or **IN 4** jack.

Proper decoding will not be possible if the mid and side are connected in reverse.

2. On the **MIXER** page, select the **MS** item. (see “Menu operation procedures” on page 12)

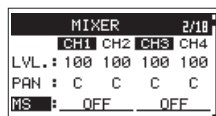

3. Set the decoding mode when using a mid-side mic.

Option	Meaning
OFF (default value)	Record in ordinary stereo mode.
REC	Use to decode while recording. Playback is conducted without decoding.
MONI	Record mid-side mic output without decoding for decoding later. Use this mode to monitor when recording with a mid-side mic. Use this also when playing back mid-side files that were recorded without decoding.

4. When finished, press the **MENU** button to return to the Home Screen.

5. When recording, a decoded signal will be recorded. When playing back, decoding will occur while playing back.

Adjusting the stereo width

When the **MIXER** page **MS** item is set to **REC** or **MONI**, the **PAN** item changes to the **WIDE** item that allows you to adjust the width of the sound.

To decode at the input, set the **MS** item to **REC**. To decode during playback, set it to **MONI**.

Option	Function
0-100	Adjust the stereo width.

At 0, the sound will be 100% mid. The amount of side increases with the value.

Setting the GANG operation mode

Setting the **GANG** operation mode allows the control of multiple knobs (1, 2, 3 and 4) to be linked.

Knobs can be ganged in 2 groups. In each group, the lowest numbered knob becomes the master and the other knobs become slaves.

The slaves are linked to operation of the master knob. Operation of the slave knobs has no effect.

1. On the **TRIM GANG** page, select the **GRP1** or **GRP2** item. (see “Menu operation procedures” on page 12)

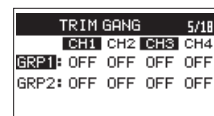

GRP1: Set to GANG group 1

GRP2: Set to GANG group 2

2. Select a channel to turn its **GANG** operation mode on or off. Options: OFF (default), ON
3. When finished, press the **MENU** button to return to the Home Screen.

NOTE

- A channel cannot be turned on for both group 1 and group 2 at the same time.
- If a slave reaches its maximum or minimum value before the master, the master can still continue to be operated. In this case, differences in levels are remembered by the unit. When Master operation is reversed, level differences will be retained when the slave is operated.

8 – Connecting with a Computer

By connecting this unit with a computer using the USB cable, you can transfer audio files on the SD card in the unit to a computer, as well as transfer audio files on the computer to the SD card in the unit.

This unit can handle audio files of the following formats.

WAV: 44.1/48/96/192kHz, 16/24-bit

BWF: 44.1/48/96/192kHz, 16/24-bit

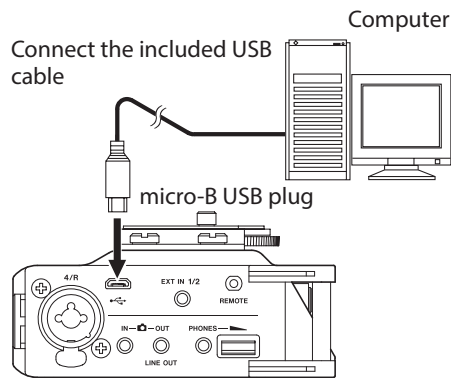

NOTE

- We recommend connecting this unit to a computer that supports USB 2.0 high-speed mass storage.
- Instead of using USB to connect the unit and a computer, you can also conduct the same operations by removing the SD card from the unit and connecting it directly to a computer that has a built-in SD card slot or by using a card reader.
- Both WAV and BWF files use the same “.wav” extension.

CAUTION

- You cannot use this unit's other functions when it is connected to a computer by USB and STORAGE is selected.
- The unit should be connected directly with the computer instead of via a USB hub.

When the USB cable is connected while the unit is on and when the unit is turned on with the USB cable already connected, the USB SELECT screen appears where you can choose between USB bus power supply or computer connection.



Turn the DATA dial to select STORAGE, and press the DATA dial to connect the unit with the computer. The USB connected message appears on the display.



Make sure that the SD card is inserted in the unit properly.

NOTE

Power is supplied from the USB port if the USB cable is connected to the unit even if it contains batteries. (USB bus power is prioritized.)

This unit appears on the computer as an external drive named “DR-701D” (if the card was formatted by this unit).

Transferring files to a computer

1. Click the “DR-701D” drive on the computer screen to show the “SOUND” and “UTILITY” folders.
2. Open the “SOUND” folder and drag and drop the files that you want to transfer to the computer to destinations of your choice.

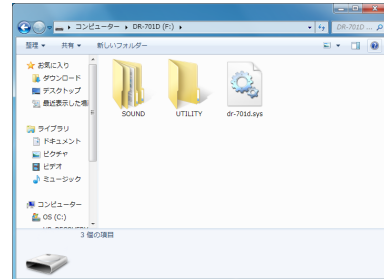

Transferring files from a computer

1. Click the “DR-701D” drive on the computer screen to show the “SOUND” and “UTILITY” folders.
2. Drag and drop files on the computer that you want to transfer to the unit to the “SOUND” folder.

TIP

- You can manage the SOUND folder from the computer.
- You can create subfolders in the SOUND folder. Subfolders can be made to two levels. The unit cannot recognize subfolders and audio files on the third level or below.
- If you name the subfolders and music files, these names will appear on the screen of this unit.

Disconnecting from a computer

Before disconnecting the USB cable, use the proper procedures for your computer to unmount the unit (as an external drive).

The unit turns off (enters standby) after it completes its shutdown process.

See the computer's operation manual for instructions about how to unmount an external drive.

9 – Settings and Information

You can change various settings to optimize the device for your use environment and other requirements.

Setting the file name format

You can select the format of names given to files recorded by this unit.

1. On the **FILE** page, select the **NAME TYPE** item. (see “Menu operation procedures” on page 12)

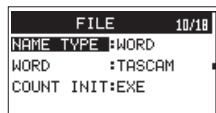

2. Set the file name format.

Option	Meaning
WORD (default)	The 6-character file name set with the WORD item is used as the file name. Example: TASCAM_0001_12.wav
DATE	The date is used as the file name (in yymmdd format). Example: 141001_0001_12.wav

NOTE

The date is set using the unit's internal clock. (see “Setting the date and time” on page 15)

Setting the WORD item

On the **WORD** item, press the **DATA** dial and move the cursor. Then, turn the **DATA** dial to set the character.

In addition to the alphabet and numbers, the following characters can be used:

! # \$ % & ' () + , - . : ; = @ [] ^ _ ` { } ~

Resetting the count

On the **COUNT INIT** item, press the **DATA** dial to reset the count. The numbers added to file names (characters set by **WORD** or the date) created after this will restart from "0001".

Format an SD card

Follow this procedure to format an SD card.

Formatting erases all music files on the SD card and automatically creates new “SOUND” and “UTILITY” folders as well as a “dr-701d.sys” file.

CAUTION

When formatting a card, the unit should be operating on AC power supplied by a TASCAM PS-P515U adapter (sold separately), USB bus power supplied from a computer, or batteries with sufficient remaining power.

If the power fails during formatting, the formatting may not occur correctly.

1. On the **MEDIA** page, select the **FORMAT** item. (see “Menu operation procedures” on page 12)



2. Set the type of formatting.

Option	Meaning
QUICK (default)	Execute quick formatting.
ERASE	Erase and format the card.

NOTE

Using the **ERASE** option might restore an SD card that has decreased writing performance due to repeated use.

3. Press the **DATA** dial to open a pop-up confirmation window.



QUICK selected

ERASE selected

4. Press the **DATA** dial to start formatting. Press the **1/■** button to cancel starting formatting.

Adjusting the display contrast

While pressing and holding the **MENU** button, turn the **DATA** dial to adjust the display contrast.

Setting the peak hold time

You can set the level meter peak hold time.

1. On the **METER/TRIM** page, select the **PEAK HOLD** item. (see “Menu operation procedures” on page 12)



2. Set the level meter peak hold time.
Options: OFF, 1sec, 2sec (default), 10sec, HOLD (always shown)
3. When finished, press the **MENU** button to return to the Home Screen.

NOTE

When the Home Screen is open, turn the **DATA** dial to reset peak hold display.

Setting trim operation mute

You can set whether or not minimizing the **1/2/3/4** knob values mutes or not when the Home Screen is in trim display mode.

1. On the **METER/TRIM** page, select the **TRIM MIN** item. (see “Menu operation procedures” on page 12)



2. Set the trim curve.

Option	Meaning
MIN	Minimizing the 1/2/3/4 knob values does not mute.
MUTE (default)	Minimizing the 1/2/3/4 knob values mutes.

3. When finished, press the **MENU** button to return to the Home Screen.

Making power management settings

You can make various power management settings on the **POWER MANAGEMENT** page. (see “Menu operation procedures” on page 12)

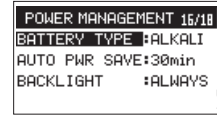

Setting the type of batteries

Use the **BATTERY TYPE** item to set the type of batteries used. This setting is used to show the amount of remaining battery charge and determine if the unit has enough power for normal operation.

Options: ALKALI (alkaline, default), Ni-MH (nickel-metal hydride), LITHIUM (lithium)

Set the automatic power saving function

Use the **AUTO PWR SAVE** item to set the amount of time from when the unit last operated or was used until the unit automatically turns off (enters standby).

Options: OFF (unit does not automatically turn off), 3min, 5min, 10min, 30min (default)

Setting the backlight

Use the **BACKLIGHT** item to set the time until the backlight automatically dims after the last operation when powered by batteries.

Options: OFF (unlit), 5sec (default), 10sec, 15sec, 30sec, ALWAYS (always stays lit)

Restoring factory default settings

You can restore the various settings stored in the backup memory of the unit to their factory default values.

1. On the **SYSTEM** page, select the **INITIALIZE** item. (see “Menu operation procedures” on page 12)

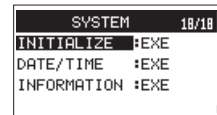

2. Press the **DATA** dial.
A confirmation pop-up message appears.



3. Press the **DATA** dial to initialize the unit.
Press **1/■** to cancel starting initialization.

9 – Settings and Information

Viewing File Information

Use the **INFORMATION** screen to view various types of information about the unit.

Follow the procedures below to view the **INFORMATION** screen.

1. Select the **INFORMATION** item on the **SYSTEM** page, and press the **DATA** dial. (see “Menu operation procedures” on page 12)

The **INFORMATION** screen opens.

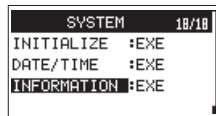

The **PROJECT (1/3)** page of the **INFORMATION** screen is shown.

The **INFORMATION** screen contains the following pages.

2. Turn the **DATA** dial to change the page shown.

The pages show the following information.

PROJECT (1/3) page:

Shows information about the currently loaded audio file.

CARD (2/3) page:

Shows the use status of the currently loaded SD card.

SYSTEM (3/3) page:

Shows the unit's system setting information and firmware version.

3. When finished, press the **MENU** button to return to the Home Screen.

File information page (PROJECT)

The **PROJECT (1/3)** page shows information about the currently loaded audio file.

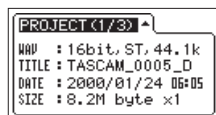

■ WAV/BWF

This shows the audio file type.

Bit length, stereo/mono, and sampling frequency (Hz) also appear.

■ TITLE

This shows the project name.

■ DATE

Date of file creation

■ SIZE

This shows the file size.

Card information page (CARD)

The **CARD (2/3)** page shows the status of the currently loaded SD card.

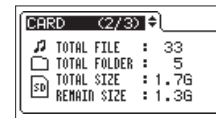

■ TOTAL FILE

This shows the number of playable files in the **SOUND** folder.

■ TOTAL FOLDER

This shows the total number of folders in the **SOUND** folder.

■ TOTAL SIZE

This shows the total SD card capacity.

■ REMAIN SIZE/USED SIZE

This shows the amount of unused/used capacity on the SD card.

Press the **4/|◀◀** or **3/▶▶|** button to switch between **REMAIN SIZE** and **USED SIZE**.

System information page (SYSTEM)

The **SYSTEM (3/3)** page shows information about the unit's system settings and firmware version.

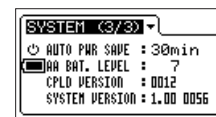

■ AUTO PWR SAVE

This shows the automatic power saving function time setting.

■ AA BAT. LEVEL

This shows if the the unit is being powered by USB and the remaining power of the batteries loaded in the unit's battery compartment.

■ CPLD VERSION

This shows the CPLD version.

■ System VERSION

This shows the system firmware version.

10 – Using the REMOTE jack

This unit has a **REMOTE** jack

Connect a TASCAM RC-3F footswitch or TASCAM RC-10 wired remote control (both sold separately) here to enable remote operation of this unit.

Using a footswitch (TASCAM RC-3F)

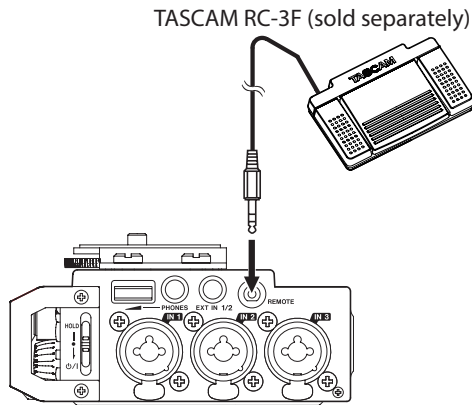

Setting up the footswitch

1. On the **REMOTE** page, select the **CONTROLLER** item. (see “Menu operation procedures” on page 12)
2. Set the **CONTROLLER** item to **RC-3F** (default).

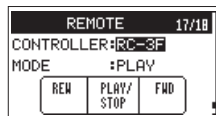

3. Select the **MODE** item and set the footswitch mode.

MODE	Footswitch		
	L	C	R
PLAY	REW	PLAY/ STOP	FWD
REC 1	STOP	REC	INC (file incrementation function)
REC 2	STOP	REC	SLATE

4. When finished, press the **MENU** button to return to the Home Screen.

Using the footswitch

Press the pedals of the footswitch to use the operations assigned to them on the **REMOTE** page.

Using a remote control (TASCAM RC-10)

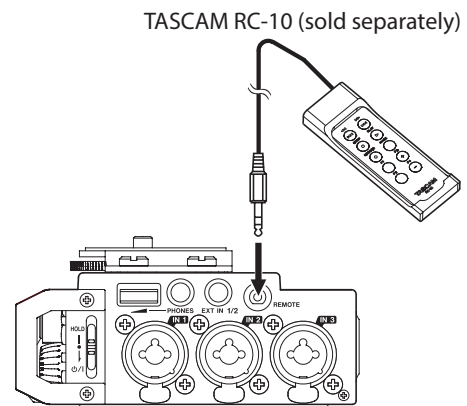

Setting up a remote control

1. On the **REMOTE** page, select the **CONTROLLER** item. (see “Menu operation procedures” on page 12)
2. Set the **CONTROLLER** item to **RC-10** (default: RC-3F).

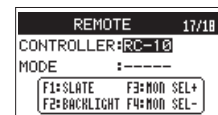

Function buttons			
F1	F2	F3	F4
SLATE	Backlight Always ON/ Backlight OFF	MONITOR SELECT +	MONITOR SELECT -

3. When finished, press the **MENU** button to return to the Home Screen.

Using the remote control

Press the function (**F1–F4**) buttons on the TASCAM RC-10 remote control to use the operations assigned to them on the **REMOTE** page.

11 – Messages

The following is a list of the pop-up messages.

Refer to this list if one of these pop-up messages appears on the DR-701D and you want to check the meaning or determine a proper response.

Message	Meaning and response
Battery Empty	The batteries are almost out of power. Replace the batteries.
Card Error	The SD card could not be recognized properly. Change the card.
Card Full	The SD card has no remaining space. Erase unnecessary files or move them to a computer to make open space.
File Full	The total number of folders and files exceeds the limit of 5000. Erase unnecessary folders and files or move them to a computer.
File Not Found	A file cannot be found or a file might be damaged. Please check that file.
File Not Found Make Sys File	The system file is missing. This unit requires a system file for operation. When this message appears, press the DATA dial to automatically create a system file.
File Protected	The file is read only and cannot be erased.
Format Error Format CARD	The SD card is not formatted properly or the card is broken. This message also appears if the card was formatted using a computer connected by USB or if an unformatted card is inserted in the unit. Always use the DR-701D to format cards to be used with it. Change the card or press the DATA dial while this message is being shown to format the card. Formatting will erase all the data on the SD card.
Invalid Card Change Card	Something might be wrong with the SD card. Change the SD card.
Invalid SysFile Make Sys File	The system file required to operate this unit is invalid. When this message appears, press the DATA dial to automatically create a new system file.
Layer too Deep	Folders can be created down to two layers. You cannot create a new folder inside the current folder.
MBR Error Init CARD	The SD card is not formatted properly or the card is broken. Change the card or press the DATA dial while this message is being shown to format the card. Formatting will erase all the data on the SD card.
No Card	No SD card is loaded in the unit. Insert a recordable SD card.
No PB File	There is no file that can be played back. The file might be damaged.
Non-Supported	The audio file is not a supported format. Please see "8 – Connecting with a Computer" on page 35 for file formats that this unit can use.
Switched To Internal Battery	The power source has switched from USB bus power to the batteries in the unit.
Write Timeout	Writing to the SD card timed out. Backup files on the card to a computer, and format the card.
No Rec Channels Selected	No recording channels have been selected (all are off).

Message	Meaning and response
HDMI CONNECTED	HDMI is connected.
LOCK to HDMI.	The clock master will switch to HDMI.
HDMI DISCONNECTED	HDMI became disconnected.
LOCK to INTERNAL	The clock master will switch to internal.
-HDMI CONNECTED- Mismatch Audio Clock. Change to **kHz?	HDMI is connected. The sampling frequency is different. Do you want to change it?
Fs Mismatch	The sampling frequency was changed.
LOCK to INTERNAL.	The clock master will switch to internal.
Fs Match	The sampling frequency was changed.
LOCK to HDMI.	The clock master will switch to HDMI.
Can't Save Data	If any of these errors occurs, turn the unit off and restart it. If the power cannot be turned off, remove the batteries, disconnect the AC adapter (TASCAM PS-P515U; sold separately), and/or disconnect the USB cable if used for USB bus power supply. If these error messages continue to appear frequently, please contact a TEAC Repair Center (see back cover).
Device Error	
File Error	
Not Continued	
Player Error	
Remote Cmd	
Remote Rx	
Writing Failed	
Sys Rom Err	
System Err 50	
System Error 1	
System Error 2	
System Error 3	
System Error 4	
System Error 5	
System Error 6	
System Error 7	
System Error 8	
System Error 9	

12 – Troubleshooting

If you are having trouble with the operation of this unit, please try the following before seeking repair. If these measures do not solve the problem, please contact the store where you bought the unit or TEAC customer support (see back page).

■ The unit will not turn on.

- Confirm that the batteries are not dead.
- Confirm that the batteries are installed with the correct ⊕/⊖ orientation.
- Confirm that the AC adapter (TASCAM PS-P515U, sold separately) is securely connected to both the outlet and the unit.
- When using USB bus power, confirm that the USB cable is securely connected.
- When using USB bus power, confirm that it is not connected via a USB hub.

■ The unit turns off automatically.

Is the automatic power saving function on?(see “Set the automatic power saving function” on page 37)

- Since this unit complies with the European Standby Power Regulations (ErP), the automatic power saving function operates regardless of whether the unit is being powered by an AC adapter or batteries. If you do not want to use the automatic power saving function, set it to “OFF”. (The factory default setting is “30min”.)

■ The unit does not function.

- Confirm that the **HOLD/⏻** / **I** switch is not set to HOLD.
- Is the unit connected to a computer by a USB cable? (Does “USB connected” appear on the display?)

■ The SD card is not recognized.

- Confirm that the SD card is inserted completely.

■ Playback is not possible.

- If you are trying to play a WAV file, confirm that the sampling frequency is supported by this unit.

■ No sound is output.

- Is the monitoring system connected properly?
- Is the volume of the monitoring system minimized?
- Is the output level setting of the unit minimized?

■ Recording is not possible.

- Check connections with other equipment again.
- Check the input settings again.
- Confirm that the input level is not too low.
- Confirm that the SD card is not full.
- Confirm that the number of files has not reached the maximum that the unit can handle.

■ The input level is low.

- Confirm that the input level setting is not too low.
- Confirm that the output level of any connected device is not too low.

■ The sound I am trying to record sounds distorted.

- Confirm that the input level setting is not too high.

■ Adjust the input knobs so that the PEAK indicators do not light.

- Lower the volumes of the sound sources being input to this unit.

■ I cannot erase a file.

- Confirm that you are not trying to erase a write-protected file that has been copied from a computer.

■ This unit’s files do not appear on the computer.

- Confirm that the unit is connected to the computer using its USB port.
- Confirm that no USB hub is being used.
- Confirm that the unit is not recording.
- Is the unit connected to a computer by a USB cable? (Does “USB connected” appear on the display?)

■ A recorded file does not contain time code data.

- Confirm that the time code input setting matches the current input source. (see “Inputting time code and adding recording start times to files” on page 28)
- Confirm that this unit is connected properly using a BNC cable with the external device that is inputting the time code.

■ The camera audio and the recording time of this unit become different.

- Confirm that this unit and the camera are connected properly using an HDMI cable.

13 – Specifications

General

■ Recording media

SD card (64 MB–2 GB)
SDHC card (4 GB–32 GB)
SDXC card (48 GB - 128GB)

■ Recording/playback formats

WAV: 44.1/48/96/192kHz, 16/24-bit
BWF: 44.1/48/96/192kHz, 16/24-bit

■ Number of input channels

4 maximum (44.1/48/96 kHz)
2 maximum (192 kHz)

■ Number of recording tracks

6 maximum (44.1/48/96 kHz)
2 maximum (192 kHz)

Input/output ratings

Analog audio input and output ratings

■ IN 1, IN 2, IN 3 and IN 4 jacks (XLR can provide phantom power)

Connectors:

XLR-3-31 (1: GND, 2: HOT, 3: COLD)
6.3mm (1/4") standard TRS jacks
(Tip: HOT, Ring: COLD, Sleeve: GND)

Input gain: When LOW/MID/HI/HI+

Input impedance: 2 k Ω

Phantom power: 48V \pm 4V (10mA/CH) or 24V \pm 4V (10mA/CH)

Maximum input level: +4 dBu

Minimum input level: –72 dBu

Mic input gain (when trim at max)

LOW: +20 dB

MID: +40 dB

HI: +52 dB

HI+: +64 dB

Input gain: When LINE

Input impedance: 10 k Ω or more

Nominal input level: +4 dBu

Maximum input level: +24 dBu

■ EXT IN 1/2 jack (can provide plug-in power)

Connector: 3.5mm (1/8") stereo mini jack

Input impedance: 10 k Ω

Maximum input level: +10 dBV

Minimum input level: -50 dBV

Mic input gain (when trim at max)

LOW: +3 dB

MID: +11 dB

HI: +26 dB

HI+: +38 dB

■ IN connector

Connector: 3.5mm (1/8") stereo mini jack

Input impedance: 10 k Ω

Nominal input level: –10 dBV

Maximum input level: +6 dBV

■ PHONES jack

Connector: 3.5mm (1/8") stereo mini jack

Maximum output: 50mW + 50mW

■ OUT connector

Connector: 3.5mm (1/8") stereo mini jack

Output impedance: 200 Ω

Nominal output level: –44 dBV

Maximum output level: +6 dBV

Notes:

The maximum input level is the level that the input knob can be adjusted and a digital full-scale (0 dBFS) signal can be input without distorting.

The minimum input level is the level that the input knob can be adjusted and a –20dBFS signal can be input.

■ LINE OUT jack

Connector: 3.5mm (1/8") stereo mini jack

Output impedance: 200 Ω

Nominal output level: –14 dBV

Maximum output level: +6 dBV

Control input/output ratings

■ HDMI IN/OUT ports

Connector: Type A receptacle

■ USB port

Connector type: Micro-B

Format: USB 2.0 HIGH SPEED mass storage class

■ TIME CODE IN connector

Connector: BNC

Signal voltage amplitude: 0.5–5 Vp-p

Input impedance: 10 k Ω

Format: SMPTE 12M-1999 compliant

■ REMOTE jack

Connector: 2.5mm TRS jack

Audio performance

■ Frequency response

20 Hz – 20 kHz +0.5/–1 dB

(LINE IN to LINE OUT, Fs 48kHz, JEITA)

20 Hz – 40 kHz +0.5/–1 dB

(LINE IN to LINE OUT, Fs 96kHz, JEITA)

20 Hz – 80 kHz +0.5/–5 dB

(LINE IN to LINE OUT, Fs 192kHz, JEITA)

■ Distortion

0.007% or less

(MIC IN to LINE OUT, –10dBu input, Fs 44.1/48/96/192kHz, JEITA)

■ S/N ratio

100 dB or higher

(LINE IN or MIC IN to LINE OUT, Fs 44.1/48/96/192kHz, JEITA)

■ Equivalent input noise (EIN)

–124 dBu or lower

Note: based on JEITA CP-2150

General

■ Power

4 AA batteries (alkaline, NiMH or lithium)

AC adapter (TASCAM PS-P515U, sold separately)

External battery pack (TASCAM BP-6AA, sold separately)

■ Power consumption

6.5W (maximum)

■ Current consumption (USB bus power)

1.3A (maximum)

■ Battery operation time (continuous operation)

- Using alkaline batteries (EVOLTA)

Use conditions	Operation time (in hours and minutes)
Channels 1/2 unused, built-in mic used for channels 3/4 Phantom power unused HDMI not connected Recording 2ch 48kHz/16-bit WAV files	About 3:45
Channels 1/2 used, channels 3/4 unused 3mA phantom power used for 2 channels HDMI not connected Recording 2ch 48kHz/16-bit WAV files	About 2:00
Channels 1/2 used, channels 3/4 unused 3mA phantom power used for 2 channels HDMI input connected (1080i/60i) Recording 2ch 48kHz/16-bit WAV files	About 1:30

- Using NiMH batteries (eneloop)

Use conditions	Operation time (in hours and minutes)
Channels 1/2 unused, built-in mic used for channels 3/4 Phantom power unused HDMI not connected Recording 2ch 48kHz/16-bit WAV files	About 4:00
Channels 1/2 used, channels 3/4 unused 3mA phantom power used for 2 channels HDMI not connected Recording 2ch 48kHz/16-bit WAV files	About 2:30
Channels 1/2 used, channels 3/4 unused 3mA phantom power used for 2 channels HDMI input connected (1080i/60i) Recording 2ch 48kHz/16-bit WAV files	About 2:00

- Using lithium battery (Energizer ULTIMATE LITHIUM)

Use conditions	Operation time (in hours and minutes)
Channels 1/2 unused, built-in mic used for channels 3/4 Phantom power unused HDMI not connected Recording 2ch 48kHz/16-bit WAV files	About 7:30
Channels 1/2 used, channels 3/4 unused 3mA phantom power used for 2 channels HDMI not connected Recording 2ch 48kHz/16-bit WAV files	About 6:30
Channels 1/2 used, channels 3/4 unused 3mA phantom power used for 2 channels HDMI input connected (1080i/60i) Recording 2ch 48kHz/16-bit WAV files	About 3:30

■ TASCAM BP-6AA (sold separately) continuous battery operation time

- Using alkaline batteries (EVOLTA) + BP-6AA (EVOLTA)

Use conditions	Operation time (in hours and minutes)
Channels 1/2 unused, built-in mic used for channels 3/4 Phantom power unused HDMI not connected Recording 2ch 48kHz/16-bit WAV files	About 9:00
Channels 1/2 used, channels 3/4 unused 3mA phantom power used for 2 channels HDMI not connected Recording 2ch 48kHz/16-bit WAV files	About 6:30
Channels 1/2 used, channels 3/4 unused 3mA phantom power used for 2 channels HDMI input connected (1080i/60i) Recording 2ch 48kHz/16-bit WAV files	About 3:45

13 – Specifications

- Using NiMH batteries (eneloop) + BP-6AA (EVOLTA)

Use conditions	Operation time (in hours and minutes)
Channels 1/2 unused, built-in mic used for channels 3/4 Phantom power unused HDMI not connected Recording 2ch 48kHz/16-bit WAV files	About 9:30
Channels 1/2 used, channels 3/4 unused 3mA phantom power used for 2 channels HDMI not connected Recording 2ch 48kHz/16-bit WAV files	About 7:00
Channels 1/2 used, channels 3/4 unused 3mA phantom power used for 2 channels HDMI input connected (1080i/60i) Recording 2ch 48kHz/16-bit WAV files	About 4:00

- Using lithium batteries (Energizer ULTIMATE LITHIUM) + BP-6AA (EVOLTA)

Use conditions	Operation time (in hours and minutes)
Channels 1/2 unused, built-in mic used for channels 3/4 Phantom power unused HDMI not connected Recording 2ch 48kHz/16-bit WAV files	About 12:30
Channels 1/2 used, channels 3/4 unused 3mA phantom power used for 2 channels HDMI not connected Recording 2ch 48kHz/16-bit WAV files	About 7:30
Channels 1/2 used, channels 3/4 unused 3mA phantom power used for 2 channels HDMI input connected (1080i/60i) Recording 2ch 48kHz/16-bit WAV files	About 5:30

■ Dimensions

169 × 57.3 × 113.5mm (W × H × D with top adapter attached)

■ Weight

654 g (including batteries)/561 g (not including batteries)

■ Operating temperature range

0°C–40°C (32°F–104°F)

NOTE

When using phantom power, the operation time might be reduced depending on the mic being used.

Dimensional drawings

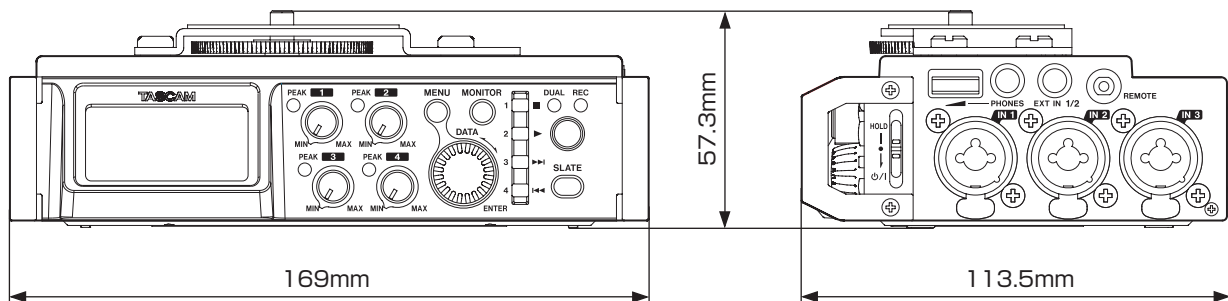

- Illustrations in this manual might differ in part from the actual product.
- Specifications and external appearance might be changed without notification to improve the product.

TASCAM

TEAC CORPORATION

Phone: +81-42-356-9143

1-47 Ochiai, Tama-shi, Tokyo 206-8530 Japan

<http://tascam.jp/>

TEAC AMERICA, INC.

Phone: +1-323-726-0303

1834 Gage Road, Montebello, California 90640 USA

<http://tascam.com/>

TEAC MEXICO, S.A. de C.V.

Phone: +52-55-5010-6000

Río Churubusco 364, Colonia Del Carmen, Delegación Coyoacán, CP 04100, México DF, México

<http://teacmexico.net/>

TEAC UK Ltd.

Phone: +44-8451-302511

2 Huxley Road, Surrey Research Park, Guildford, GU2 7RE, United Kingdom

<http://tascam.eu/>

TEAC EUROPE GmbH

Phone: +49-611-71580

Bahnstrasse 12, 65205 Wiesbaden-Erbenheim, Germany

<http://tascam.eu/>

TEAC SALES & TRADING(SHENZHEN) CO., LTD

Phone: +86-755-88311561~2

Room 817, Block A, Hailrun Complex, 6021 Shennan Blvd., Futian District, Shenzhen 518040, China

<http://tascam.cn/>
