

HASSELBLAD

X2D 100C

User Manual

v1.2 2022.12

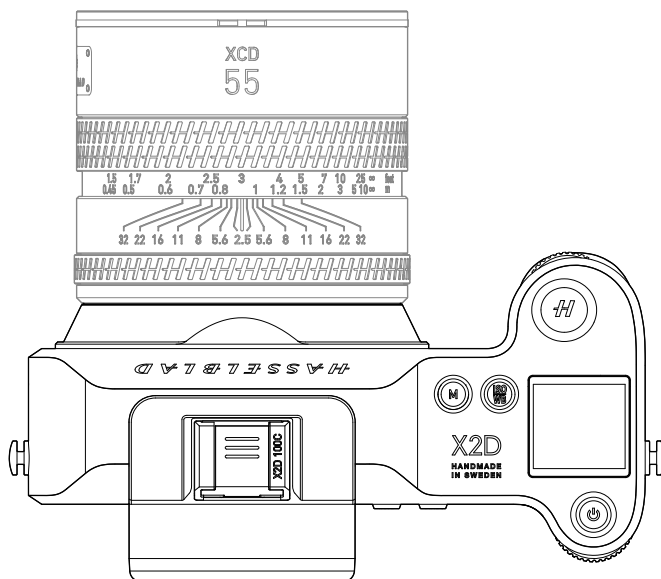

 **Searching for Keywords**

Search for keywords such as “battery” and “install” to find a topic. If you are using Adobe Acrobat Reader to read this document, press Ctrl+F on Windows or Command+F on Mac to begin a search.

 **Navigating to a Topic**

View a complete list of topics in the table of contents. Click on a topic to navigate to that section.

 **Printing this Document**

This document supports high resolution printing.

Revision Log

| Version | Date | Revision |
|---------|---------|---|
| v1.2 | 2022.12 | Added mass storage function description |

CONTENTS

| | | |
|----------|---|-----------|
| 1 | PRODUCT PROFILE | 10 |
| 1.1 | Introduction | 11 |
| 1.2 | Feature Highlights | 11 |
| | 100-Megapixel Medium Format BSI CMOS Sensor | 11 |
| | HNCS | 11 |
| | 5-Axis 7-Stop In-Body Image Stabilisation | 11 |
| | Phase Detection Autofocus | 11 |
| | Built-in 1TB SSD | 12 |
| | Electronic Viewfinder with 1.0x Magnification | 12 |
| | Tilting Touch Display and Top Display | 12 |
| | Phocus Mobile 2 and Phocus | 12 |
| | High-Speed Transmission | 12 |
| | Hasselblad Lenses to Match | 12 |
| | XCD System Lenses | 12 |
| | H System Lenses | 13 |
| | V System and XPan System Lenses | 13 |
| 1.3 | Specifications | 14 |
| 1.4 | Charging the Battery | 16 |
| | How to Charge | 16 |
| | Charging Indicators | 17 |
| 1.5 | Mounting the Lens | 18 |
| 1.6 | Mounting the Lens Shade | 19 |
| 1.7 | Inserting the Memory Card | 20 |
| 1.8 | Attaching the Shoulder Strap | 21 |
| 2 | FUNCTIONS | 22 |
| 2.1 | Overview | 23 |
| 2.2 | Interaction Displays | 28 |
| 2.3 | Touch Display | 30 |
| | Touch Display Operations | 30 |
| | Touch Controls | 30 |
| | Button and Scroll Wheel Controls | 31 |

| | |
|---|----|
| Screen Switch | 32 |
| Live View | 34 |
| Exposure Information Display | 34 |
| Exposure Information + Grid Overlay | 36 |
| Exposure Information + Distance Scale Overlay | 36 |
| Exposure Information + Spirit Level Overlay | 36 |
| Control Screen | 37 |
| Enter/Exit Control Screen | 37 |
| Locked Parameters on Control Screen | 38 |
| Settings on Control Screen | 39 |
| Browse Mode | 42 |
| 2.4 Top Display | 43 |
| 2.5 Exposure Modes | 45 |
| Selecting Exposure Mode | 45 |
| Manual Exposure | 47 |
| Automatic Exposure | 48 |
| Auto Exposure Lock | 49 |
| 2.6 Focus Modes | 50 |
| Selecting Focus Mode | 50 |
| Auto Focus | 52 |
| Focus Point | 53 |
| Autofocus Single | 54 |
| Manual Focus | 55 |
| Manual Focus in Live View | 55 |
| Enabling MF Assist | 55 |
| Auto Zoom | 56 |
| Focus Indicator | 57 |
| Moving and Adjusting Focus Point | 58 |
| 2.7 Drive Modes | 59 |
| Selecting Drive Mode | 59 |
| Single | 60 |
| Continuous | 60 |
| Self Timer | 60 |
| Interval | 61 |
| Exposure Bracketing | 62 |
| 2.8 Image Stabilisation | 63 |

| | | |
|------|-------------------------------------|----|
| 2.9 | Built-in SSD | 64 |
| | Storing Files to SSD | 64 |
| | Formatting SSD | 64 |
| | Checking SSD Storage Status | 64 |
| | Using the SSD as Mass Storage | 64 |
| 2.10 | Memory Cards | 65 |
| | Recommended Memory Cards | 65 |
| | Storing Files to Memory Card | 65 |
| | Formatting Memory Card | 65 |
| | Checking Memory Card Storage Status | 65 |
| 2.11 | Electronic Viewfinder (EVF) | 66 |
| | Screen Display | 66 |
| | Dioptre Adjustment | 66 |
| | Touchpad Operations | 66 |
| | Setting Touchpad Area | 66 |
| | Moving Focus Point | 67 |
| | Zooming In/Out | 67 |
| 2.12 | Image Browsing | 68 |
| | Browsing Images | 68 |
| | Standard Preview Mode | 69 |
| | 9 View Mode | 69 |
| | Capture Details Mode | 70 |
| | Separate Histogram RGB Mode | 70 |
| | Luminance Histogram Mode | 70 |
| | Luminance Histogram Exposure | 71 |
| | Selecting Folder to Browse | 72 |
| | Creating Folders | 72 |
| | Image Rating | 73 |

3 SETTINGS 74

| | | |
|-----|-----------------------|----|
| 3.1 | Main Menu | 75 |
| 3.2 | Exposure Settings | 76 |
| | Exposure Compensation | 76 |
| | Reset After Exposure | 76 |
| | Reset After Reboot | 76 |
| | Shutter Function | 77 |

| | |
|---------------------------------|----|
| Electronic Shutter | 77 |
| True Exposure | 77 |
| Shutter Speed Limit | 79 |
| Auto ISO Limits | 80 |
| Exposure Simulation | 80 |
| Configuration | 81 |
| Exposure Lock | 81 |
| Increment Step Size | 81 |
| B/T Mode | 81 |
| Lens | 82 |
| 3.3 Focus Settings | 83 |
| Autofocus | 83 |
| AF Point Size | 83 |
| Reset Focus Point | 83 |
| AF Results Sound | 83 |
| Manual Focus | 84 |
| MF Assist | 84 |
| Move AF Point | 84 |
| Move AF Point for EVF | 84 |
| 3.4 Quality Settings | 85 |
| Image Format | 85 |
| Bit Depth | 85 |
| 3.5 Flash Settings | 86 |
| Sync | 86 |
| Exposure Lock until Flash Ready | 86 |
| 3.6 Display Settings | 87 |
| EVF-Rear Screen | 87 |
| EVF | 88 |
| EVF Dioptre | 88 |
| Eye Sensor Distance | 88 |
| Always start Live View in EVF | 88 |
| Brightness | 88 |
| Rear Screen Brightness | 88 |
| Top Display Brightness | 88 |
| EVF Brightness | 88 |
| Preview | 89 |

| | |
|----------------------------|-----|
| Preview Time | 89 |
| Rear Screen | 89 |
| EVF | 89 |
| Overexposure Warning | 89 |
| 3.7 Power Settings | 90 |
| Display Off | 90 |
| Power Off | 90 |
| Power Off when Tethered | 90 |
| 3.8 Storage Settings | 91 |
| Destination | 91 |
| Primary Slot | 91 |
| Secondary Storage | 91 |
| Info | 92 |
| Format | 92 |
| 3.9 Stabilisation Settings | 93 |
| Stabilisation | 93 |
| Focal Length | 93 |
| 3.10 Wi-Fi Settings | 94 |
| 3.11 General Settings | 96 |
| Touch | 96 |
| Touchpad for EVF | 97 |
| Custom Buttons | 98 |
| Custom Buttons | 98 |
| Reset Custom Buttons | 98 |
| Custom Profiles | 99 |
| Spirit Level Calibration | 100 |
| Date & Time | 102 |
| Language & Unit | 102 |
| Language | 102 |
| Unit of Distance | 102 |
| Service | 103 |
| Firmware Update | 103 |
| Default Settings | 104 |
| File Counter | 104 |
| Log Data | 104 |
| About | 105 |

| | | |
|----------|-------------------------------------|------------|
| 4 | PHOCUS MOBILE 2 AND PHOCUS | 106 |
| 4.1 | Profile | 107 |
| 4.2 | Phocus Mobile 2 App | 108 |
| 4.3 | Phocus Software | 109 |
| | Connecting to Computer | 109 |
| | Professional Image Quality | 110 |
| | Phocus and Hasselblad Capture Files | 110 |
| 5 | APPENDIX | 111 |
| 5.1 | Change From Foreign Language | 112 |
| 5.2 | ERROR MESSAGES | 113 |
| 5.3 | Clean the Sensor Filter | 113 |
| 5.4 | Clean the Lens Glass Surface | 114 |
| | Remove Dust | 114 |
| | Remove Smear | 114 |
| 5.5 | EV VALUE | 114 |
| 5.6 | Accessories | 116 |
| | XH Lens Adapter | 116 |
| | XH CONVERTER 0,8 | 117 |
| | XV Lens Adapter | 118 |
| | Tripod Mount Ring 75mm | 118 |
| | XPan Lens Adapter | 119 |
| | Battery Charging Hub | 119 |
| | Optional HC Lens Accessories | 120 |
| | H 13, 26, and 52 Extension Tubes | 120 |
| | Converter H 1.7x | 120 |
| | Tilt/Shift Adapter HTS 1.5x | 120 |
| | Optional Accessories | 121 |
| | Pro Shade V/H 60-95 | 121 |
| | Pro Shade Adapters | 121 |
| | UV Sky Filters | 121 |
| | Pola Filters | 122 |
| | Tripod Quick Coupling H | 122 |

USING THIS MANUAL

LEGEND

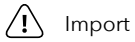

Import



Hints and tips

BEFORE USE

The following documents have been produced to help users safely operate and make full use of the product:

1. In the Box
2. Disclaimer and Safety Guidelines
3. Quick Start Guide
4. User Manual

Refer to X2D 100C In the Box to check the listed parts and read the disclaimer and safety guidelines before use. Refer to the quick start guide for more information on assembly and basic features and functions. Refer to the user manual for more comprehensive information.

GLOSSARY

In this user manual, a few terms are used:

Tap: this means to touch a value or icon on the display with the finger briefly. This only works with a bare finger or when special touch-display gloves are used.

Double-tap: quickly tap the same location on the display within 1 second. This is mainly used to zoom in or out an image or Live View.

Long-press: press and hold for 1 second.

Swipe: a swiping movement is when users press and hold the finger and slide in one direction. This is typically used when selecting a value from a list or when panning in a zoomed-in image.

Spread: place two fingers on the display and move them apart. Typically used when zooming in.

Pinch: place two fingers on the display with a distance between and move the fingers together. Typically used when zooming out.

Tethering: when the camera is connected to a computer with a USB cable or an iPad/iPhone with Wi-Fi.

1 PRODUCT PROFILE

1.1 INTRODUCTION

The HASSELBLAD™ X2D 100C is Hasselblad's next-generation mirrorless medium format digital camera with a large 100-megapixel back-side illuminated (BSI) CMOS sensor that boasts 16-bit colour depth and a dynamic range of 15 stops. The camera features 5-axis, 7-stop in-body image stabilisation (IBIS). Hasselblad Natural Colour Solution (HNCS) technology is integrated into the camera's system, delivering superb, true-to-life tones that match what the human eye sees. The X2D 100C offers more storage with a built-in 1TB SSD. Users can expand the capacity further with a CFexpress Card Type B.

The 5.76-million-dot OLED electronic viewfinder (EVF) features electronic dioptre adjustment and supports 1.0x magnification to bring an immersive viewing experience. Users can enjoy an all-new shooting experience with the 3.6-inch 2.36-million-dot tilting touch display and the new 1.08-inch full-colour top display.

1.2 FEATURE HIGHLIGHTS

100-Megapixel Medium Format BSI CMOS Sensor

Utilising a 100-megapixel medium format BSI CMOS sensor with a native ISO of 64, the X2D 100C captures life in vivid colour and exquisite detail. Over 281 trillion colours are represented with the 16-bit colour depth. This immense dimension of colour paired with 15 stops of dynamic range allows the X2D 100C to capture the subtle intricacies of highlights and shadows as they are seen in the natural world.

HNCS

The HNCS optimises colours to appear as authentically as the eye perceives them. Images are captured without any preset.

5-Axis 7-Stop In-Body Image Stabilisation

With the compact medium format IBIS solution, the X2D 100C features 5-axis 7-stop IBIS to assist in capturing crisp, handheld shots.

Phase Detection Autofocus

The X2D 100C utilises Phase Detection Autofocus (PDAF) for fast focusing. 294 PDAF zones spread over the 100-megapixel sensor surface provide swift and accurate focusing at the press of a button.

Built-in 1TB SSD

The camera offers ample storage with a built-in 1TB SSD for high-volume and high-speed storage. Additional space can be added using the CFexpress Type B card slot.

Electronic Viewfinder with 1.0x Magnification

The 5.76-million-dot OLED viewfinder supports magnification up to 1.0x, expanding the camera view for a clear and immersive experience. New electronic dioptre adjustment allows for a personally tailored view. With a clear, bright field of view, focus checking is accurate and more convenient than ever.

Tilting Touch Display and Top Display

The 3.6-inch touch display presents a clear image even under intense light and tilts to gradual angles for diverse shooting needs. It supports a resolution of 2.36 million dots, bringing accurate, true-to-life colours to view. The Hasselblad User Interface (HUI) is neat and optimised. Featuring intuitive touch control, simply slide and tap to access the most used operations. A new 1.08-inch coloured top display publishes the camera status and shooting parameters.

Phocus Mobile 2 and Phocus

The built-in Wi-Fi connectivity allows users to create a portable photography workflow with wireless shooting and export and edit images using Phocus Mobile 2 * on an iPhone or iPad. Full tethered operations include high-speed tethered shooting, and real-time RAW image processing is available using the Mac or Windows version of the Phocus software. * Both the Phocus Mobile 2 app and Phocus software use HNCS to deliver correct colours.

* Phocus Mobile 2 is compatible with iPad models with 3GB of RAM or more and with iPhone X or later models running iOS 15.0 or later. Phocus is compatible with computers with 8GB of RAM or more running on macOS 10.15 or later, or Windows 7 64-bit or later. Visit the official Hasselblad website for more information.

High-Speed Transmission

The camera has a USB-C 3.1 Gen 2 port that supports a max 10Gbps transmission rate. PD 3.0 fast charging and third-party PD 3.0 chargers are supported, removing the need to carry multiple charging devices.

Hasselblad Lenses to Match

XCD System Lenses

Supported all XCD System lenses, including the newly-launched XCD 2,5/38V, XCD 2,5/55V, and XCD 2,5/90V lenses.

H System Lenses

All H System lenses can be used with the optional XH Lens Adapter or XH Converter 0,8. Make sure to use the latest firmware for the H System lenses. Note that only certain functions of the camera are supported when using an H System lens.

V System and XPan System Lenses

V System and XPan System lenses can be used with the optional XV Lens Adapter and XPan Lens Adapter in Electronic Shutter Mode.

1.3 SPECIFICATIONS

| | |
|------------------------------------|--|
| Camera Type | Mirrorless Medium Format Digital Camera with autofocus, auto-exposure, interchangeable lenses |
| Construction | Machined aluminium. Tripod socket 1/4" |
| Sensor Type | Back-side illuminated (BSI) CMOS, 100 megapixels (11656 × 8742 pixels, pixel size 3.76µm) |
| Sensor Dimensions | 43.8 × 32.9mm |
| Image Size | Stills: 3FR RAW: capture 206MB on average |
| File Format | Hasselblad 3FR RAW, full size JPEG |
| Drive Mode | Single and Continuous Drive, Self Timer, Interval Timer, Exposure Bracketing |
| Colour Definition | 16-bit; dynamic range up to 15 stops |
| Image Stabilisation | 5-axis 7-stop in-body image stabilisation (IBIS) |
| ISO Speed Range | ISO Auto, 64, 100, 200, 400, 800, 1600, 3200, 6400, 12800, 25600 |
| Storage Options | Built-in 1TB SSD. Extra CFexpress Type B card with a max storage capacity of 512GB supported. |
| Recommended Memory Cards | Sony CEB-G series CFexpress Type B memory cards (128GB) SanDisk Extreme Pro CFexpress Type B memory cards (128GB, 256GB, 512GB) |
| Colour Management | Hasselblad Natural Colour Solution (HNCS) |
| Capture Rate | 3.3fps in a 14-bit colour depth |
| User Interface | Touch interface including swipe, scroll and pinch/spread to zoom. Camera grip with buttons and scroll wheels. |
| Touch Display | 3.6-inch TFT type, 24-bit full-colour, 2.36-million-dot. Touch functionality: full support. Tilting angle: 40°, 70° |
| Top Display | 1.08-inch TFT type, 18-bit full-colour, 158,400-dot |
| Electronic Viewfinder (EVF) | OLED, 5.76-million-dot. Viewing area: 100%. Magnification: approx. 1.00x with 65mm medium format lens at infinity, -1m ⁻¹ |
| Histogram Feedback | Yes, in Browse mode on touch display and in EVF |
| IR Filter | Mounted in front of sensor |
| Software | Phocus is compatible with computers with 8GB of RAM or more running on macOS 10.15 or later, or Windows 7 64-bit or later. Phocus Mobile 2 is compatible with iPad models with 3GB of RAM or more and with iPhone X or later models running iOS 15.0 or later. |

| | |
|------------------------------|---|
| iOS Device Support | iPad models with 3GB of RAM or more and iPhone X or later models running iOS 15.0 or later |
| Platform Support | macOS 10.15 or later, or Windows 7 64-bit or later |
| Host Connection Type | USB 3.1 Gen2 Type-C connector (transfer speed up to 10Gbit/s) |
| Operating Temperature | -10° to 45° C (14° to 113° F) |
| Operating Humidity | No more than 85% without condensation |
| Wi-Fi | 802.11b/a/g/n/ac/ax, Wi-Fi with 2×2 MIMO |
| Supported Lenses | Hasselblad XCD lenses with built-in electronically controlled leaf shutter and aperture. Automatic or manual focusing with instant manual focus override. Lens shades can be mounted in reverse for transport. Compatible with all H System Lenses and some H System accessories using the XH Lens Adapter. Also compatible with V System and XPan Lenses using the XV or XPan Lens Adapter. |
| Shutter | Electronically controlled leaf shutter with speeds up to 1/4000s. Optional electronic shutter |
| Shutter Speed | 68 min to 1/4000s with XCD Lenses. * Up to 1/800s or 1/2000s with HC/HCD Lenses. Electronic shutter 68 min to 1/6000s. |
| Flash Control | TTL centre weighted system. Compatible with Nikon System flashes. ISO range 64 to 25600. Flash output can be adjusted (-3 to +3 EV) for fill-in purposes independent of ambient light. Sync at all shutter speeds. Mechanical shutter only. |
| Flash Compatibility | In TTL-mode, the following Nikon Flash products can be used: SB-300, SB-500, SB-5000, SB-700, SB-900, SB-910. The following Profoto products can be used in TTL-mode: A1, B1 and B2 with Nikon interface. |
| Focusing | Autofocus single (AF-S) and manual focus (MF). Instant manual focus override. Automatic focusing using phase and contrast detection. Focus indicator or 100% zoom available in MF. Up to 294 Phase Detection Autofocus (PDAF) zones. |
| Exposure Metering | Spot, centre weighted, and centre spot |
| Power Supply | Rechargeable Li-ion battery (7.27VDC/3400mAh). Can be charged in-camera via the USB-C port on the camera body. Charging time is approx. two hours using the included 30W USB-C charger. |
| Dimensions | 148.5 × 106 × 74.5mm |
| Weight | 895g (camera body with the battery); 790g (camera body only) |

* The fastest shutter speed varies depending on the lens in use. Refer to the datasheet of the corresponding lens.

1.4 CHARGING THE BATTERY

The X2D 100C comes with the battery already inserted in the battery slot. Remove the protective film on the battery and fully charge before using for the first time.

How to Charge

1. Pull the battery release lever (1). The battery will pop out slightly. Press the battery gently (2) until there is a click before removing the battery. Remove the battery and the protective film (3). Insert the battery into the camera grip until the battery is secured (4).

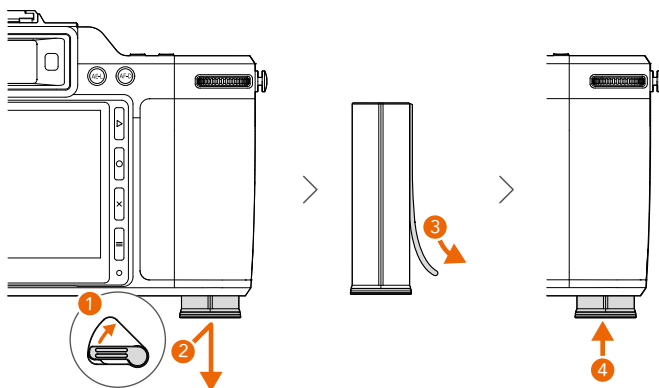

2. Slide the connector slot lid toward the touch display to open. Connect the USB-C port of the camera with the provided 30W USB-C charger using the USB-C to USB-C cable and connect the charger to a power outlet (100-220V, 50-60Hz).

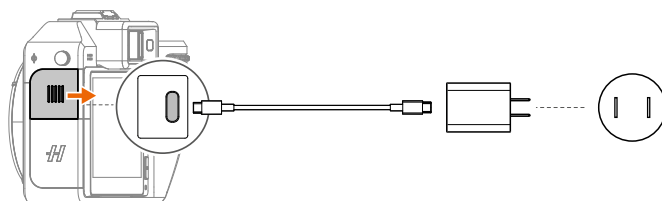

It takes approximately two hours to fully charge the battery using the provided charger.



It is recommended to use the provided charger or the Hasselblad Battery Charging Hub (not included) to charge the battery. Otherwise, use an FCC or CE certified USB PD charger.

Charging Indicators

Both the touch display and top display will show the charging indicators when charging the battery using the USB-C port on the camera.

The top display will show the charging status icon and battery level  when charging the battery with the camera powered off or in Standby Mode.

The Live View and Control Screen on the touch display will show the charging status icon and battery level  when charging the battery with the camera powered on.

1.5 MOUNTING THE LENS

The instructions below uses an XCD lens as an example. A lens adapter is required when using other lenses.

1. Press the lens removal button while turning the protection cover lid to remove the protection cover lid from the camera body.
2. Remove the lens caps and align the red dot on the lens with the red dot on the lens mount of the camera body. Attach the lens to the camera body and turn the lens clockwise until it clicks into place.
3. Make sure that the lens is firmly secured to the camera body before use or movement.

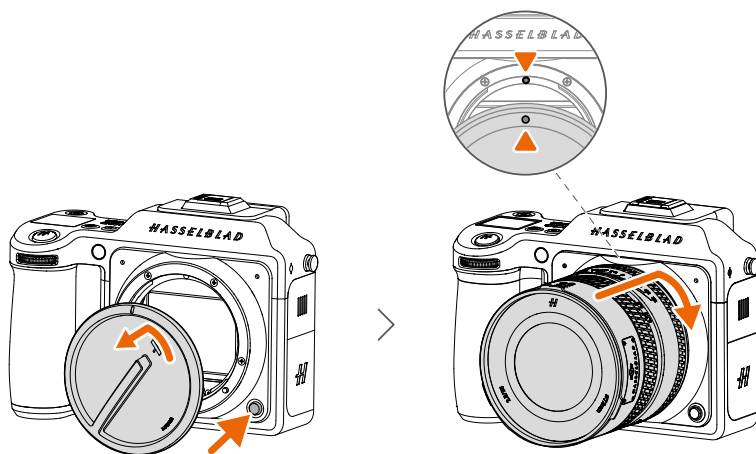

To remove the lens, press the lens removal button while rotating the lens counterclockwise. Attach the lens protection caps on the detached lens to prevent damage.



- Be careful when attaching or removing the lens to prevent damage to the metal terminals on the camera or lens.
- Do not insert fingers or any other objects into the camera body. This can cause damage to the equipment.
- Attach the protection cover lid to the camera body after removing the lens.

1.6 MOUNTING THE LENS SHADE

When mounting the lens shade normally (Figure A), align the orange mark on the lens shade and the mark on the front of the lens. Rotate the lens shade clockwise to secure it.

When mounting the lens shade in reverse (Figure B), align the white mark on the lens shade and the mark on the front of the lens. Rotate the lens shade clockwise to secure it.



Mount the lens shade in reverse for additional protection during transport and storage.

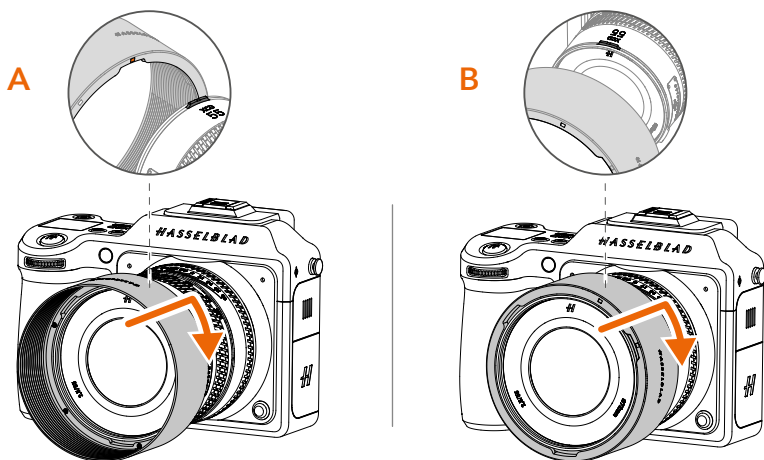

1.7 INSERTING THE MEMORY CARD

The camera is equipped with a built-in 1TB SSD. Users can expand the capacity further with a CFexpress Type B memory card. Refer to the Memory Cards section for more information about memory card instructions.

1. Slide the card slot lid toward the touch display to open.
2. Insert the memory card into the card slot gently. Pay attention to the facing direction of the memory card. If the card cannot be inserted properly, make sure it is facing the correct direction. Do not insert by force.
3. Close the card slot lid by pressing it down and sliding it in place.

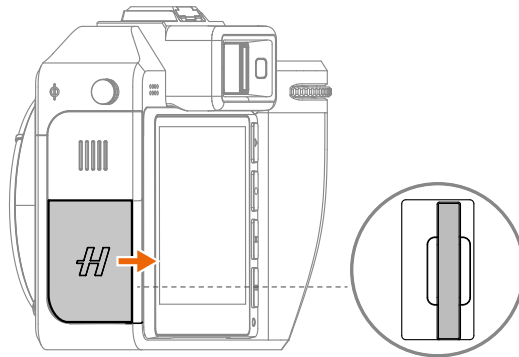

To remove the memory card, open the card slot lid, press the memory card to release it, remove it, and close the card slot lid.

1.8 ATTACHING THE SHOULDER STRAP

Attach the buckle of the shoulder strap to the strap lug on side of the camera body. Press the top part of the buckle (1) as shown in the figure below. Slide the buckle down to secure it to the strap lug (2).

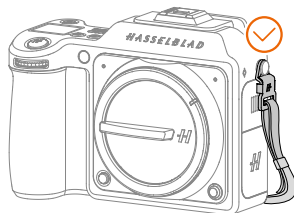
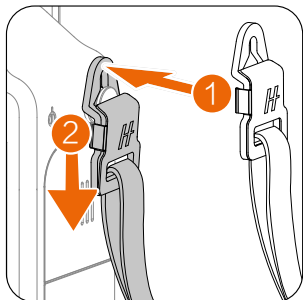

To remove the buckle, pinch both sides of the buckle, pull out the metal piece slightly, and lift the buckle.

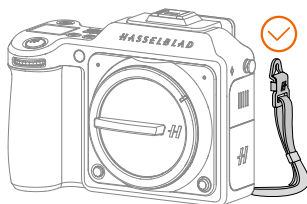
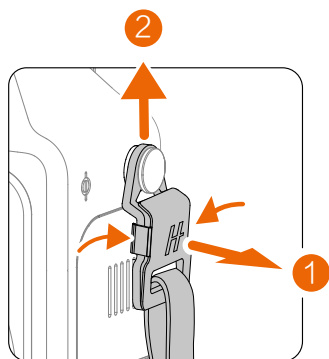

2 FUNCTIONS

2.1 OVERVIEW

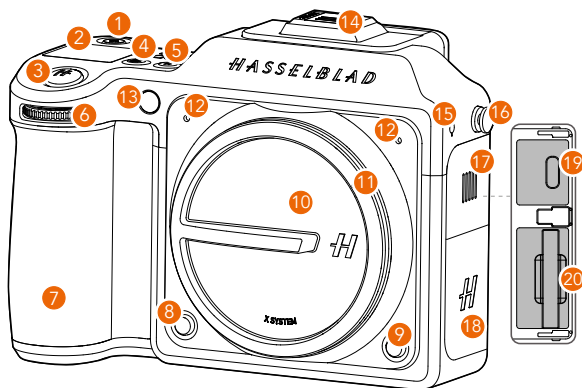

1. ON/OFF Button

When the camera is powered off, press once to check the battery level on the top display. Press and hold for 1 second to power on the camera and the “H” logo will appear on the top display and touch display.

After a few seconds (customisable) of inactivity, the camera will enter Standby Mode. Press the button once to enter or exit Standby Mode.

Press and hold the button to power off the camera completely when it is powered on (not in Standby Mode).

2. Top Display

When the camera is powered off, press the ON/OFF button once to check the battery level on the top display.

When the camera is powered on, the display will show certain camera statuses and parameters, such as ISO, battery level, aperture, shutter speed, exposure mode, and remaining frames. The display will also show the available options after entering the menu for specific settings.

3. Shutter Release Button

This button has two positions. Press half way to activate the camera from Standby Mode, start auto-focusing and exposure metering. Press all the way down to release the shutter. The chosen exposure procedure, for example, Self Timer, is also activated with this button.

4. ISO/WB Button (custom)

The default function is to set ISO and white balance (WB). Press once to enter the ISO settings and press again to enter the WB settings. Customise the button function in General Settings.

5. Exposure Mode Button (custom)

The default function is to switch the exposure mode. Press the button, and exposure modes will be shown on the touch display and top display. Toggle the front or rear scroll wheel and press the rear scroll wheel or exposure mode button to select the corresponding mode: Manual Exposure Mode (M), Aperture Priority Mode (A), Shutter Priority Mode (S), Program Mode (P), Full Auto Mode (**AUTO**). Customise the button function in General Settings.

6. Front Scroll Wheel

Toggle to adjust the aperture or shutter speed, switch between options for the camera settings, and switch images in preview.

7. Camera Grip

8. Focus Mode Button (AF/MF, custom)

The default function is to switch the focus mode. In Live View, press the button to switch between focus modes. On Control Screen, press the button and the focus modes will be shown on the touch display. Toggle the front or rear scroll wheel and press the rear scroll wheel or focus mode button to select the corresponding mode: autofocus (AF), manual focus (MF). Customise the button function in General Settings.

9. Lens Removal Button

When the lens or protective cover lid is mounted, press and hold the button while rotating the lens or the lid to remove.

10. Protective Cover Lid

11. Protective Cover Lid Index

When mounting the protective cover lid, align the index with the mark on the lens mount and rotate the lid.

12. Microphones

13. Colour Temperature Photo Sensor

Assists measuring WB when WB is set to Auto.

14. Hot Shoe Lid

Users can mount a compatible device to the hot shoe, such as a flash, after removing the hot shoe lid.

15. Focal Plane Mark

16. Strap Lugs

17. Connector Slot Lid

18. Card Slot Lid

19. USB-C Port

For charging the battery and image transmission. USB 3.1 is supported. Connect the port to the provided charger using the USB-C to USB-C cable to charge the battery. Connect the port to a computer using a USB-C cable of USB 2.0 or above to read images stored in the camera or connect to the Phocus software.

20. CFexpress Card Slot

Insert a CFexpress Type B memory card to expand storage.

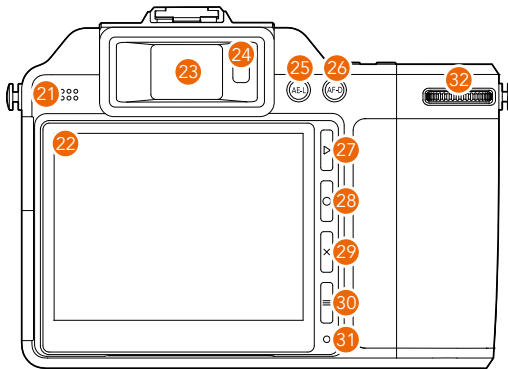

21. Speaker

22. Tilting Touch Display

The touch display is used to display information and control the camera. Its operations are similar to those on the touchscreen of a smartphone or a tablet. The touch display can be tilted up to 70° upwards. Lift the screen using the groove at the bottom of the display to tilt the display upwards. There are click-stops for 40° and 70°.

23. Electronic Viewfinder (EVF)

24. EVF Sensor

In the default settings, the camera display will switch to EVF when your eye is approaching the EVF. The EVF will turn off automatically when switching back to look at the touch display.

25. AE Lock Button (AE-L)

Automatic exposure lock. Used to lock the exposure value (EV). In Live View, press the button to lock EV in Automatic Exposure Modes (A, S, P). In Manual Exposure Mode, press the button to lock the aperture and shutter speed combination. This allows users to shift the aperture and shutter speed combination using the scroll wheels without changing the exposure. When browsing images, press the AE lock button to zoom out. After entering a menu, press the button to return to the previous menu.

26. AF Drive Button

Autofocus drive. Press to start autofocus and release to stop. During autofocus, the rectangle of the focus point on the touch display or EVF changes its colour depending on the autofocus process. Refer to the Focus Modes section for more information.

27. Browse Button

Press to preview captured images. When browsing images, zoom in or out by pinching or spreading two fingers on the touch display. Users can also use the AF-D button to zoom in and the AE-L button to zoom out.

28. Circle Button

The button has multiple functions that vary in different scenarios. In Live View or Browse Mode, press to show or hide parameter information.

29. Delete Button

The button has multiple functions that vary in different scenarios. In Browse Mode, press to delete the selected image.

30. Menu Button

In Live View, Main Menu, or Browse Mode, press to enter Control Screen. On Control Screen, press to enter Main Menu. In sub menus, press to return to Main Menu.

31. Ambient Light Sensor

32. Rear Scroll Wheel (custom clickable)

Toggle to adjust the aperture or shutter speed, switch between options for the camera settings.

The rear scroll wheel is clickable. When setting parameters, press to confirm the selected parameter. In Live View and Browse Mode, press the rear scroll wheel to zoom in on the image. This is the default function. Customise the function for pressing the rear scroll wheel in General Settings.

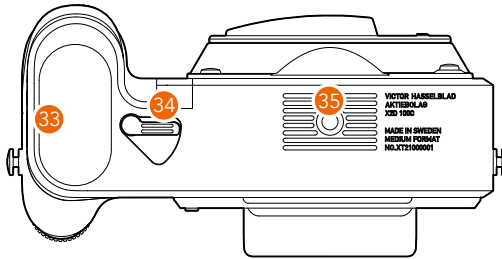

33. Battery

34. Battery Release Lever

Toggle the lever to release the battery and press the battery slightly to remove it.

35. Tripod Thread 1/4"

2.2 INTERACTION DISPLAYS

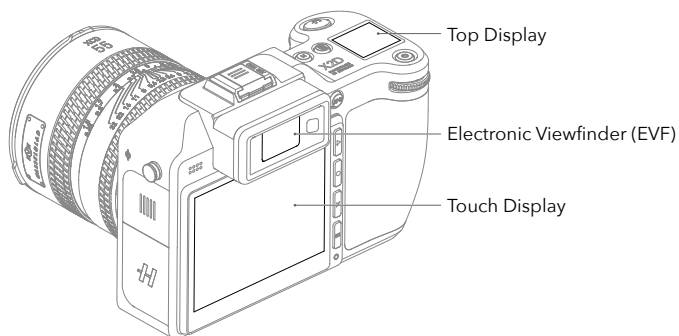

Touch Display

The rear screen is a tilting touch display and is touch sensitive and easy to operate. Use it the same way as on a smartphone. For example, swipe to scroll, tap to select, or spread and pinch to zoom in or out of images or the focus point. Users can also navigate by using the buttons to the right of the touch display and scroll wheels on the camera.



Electronic Viewfinder (EVF)

The EVF on the camera can be used for live view shooting, parameter adjustment, and image browsing for an immersive experience.



Top Display

The full-colour top display is used to show the camera status and parameters. The display will also show the available options after entering the menu for certain parameters.

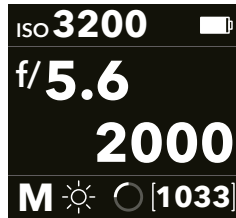

The sections below will introduce the interface for the touch display, top display, and EVF respectively.

2.3 TOUCH DISPLAY

Operate the touch display, using the buttons and scroll wheels on the camera body to control the camera. The touch display has Live View, Control Screen, Main Menu, and Browse Mode. Users can take photos, view the camera status, set parameters, and browse files in different views. This section will introduce Live View, Control Screen, and Browse Mode displays. For Main Menu displays, refer to the Settings section.

Touch Display Operations

Touch Controls

The touch display on the camera is similar to a smartphone or tablet with touch sensitivity. The following gestures can be used to navigate and control the camera:

| Action | Function |
|---------------------------------|---|
| Tap/Press | Select and confirm. |
| Double Tap | Zoom in to 100%. Double tap again to zoom out to full view. |
| Spread (move two fingers apart) | Zoom in when browsing images. |
| Pinch (move two fingers close) | Zoom out when browsing images. |
| Swipe Left | Switch the image or move the image left when browsing images. On Control Screen, switch to Main Menu. |
| Swipe Right | Switch the image or move the image right when browsing images. In Main Menu, switch to Control Screen. In sub menus, return to the previous menu. |

Button and Scroll Wheel Controls

On Control Screen, Menu Screen, and in Browse Mode, use the buttons and scroll wheels on the camera body for selection, confirmation, and back operations.

| Camera Display | Buttons/Scroll Wheels | Function |
|-------------------------------|-------------------------------|---|
| Control Screen Menu Screen | Rear Scroll Wheel | Press to select adjustable parameters on the screen or to confirm the selected option. Toggle to switch between parameters and options. |
| | Front Scroll Wheel | After an adjustable parameter is activated on the screen, toggle to switch between parameters and options. |
| | Circle Button/AF Drive Button | After an adjustable parameter is activated on the screen, press to enter the option list or to confirm a selected option. When the parameter option is a switch, press to switch between on and off. |
| | Delete Button | After an adjustable parameter is activated on the screen, press to cancel the selection or return to the previous menu. |
| Menu Screen | AE Lock Button | Return to the previous menu. |
| Browse Mode | Rear Scroll Wheel | Toggle left to return to the parent view. For example: enter the 9 images view, select folders or storage to browse. Toggle right to enter the subview. When viewing one image, toggle right to zoom in on the image. When zooming in, toggle left to zoom out. |
| | Front Scroll Wheel | Switch between captured images. |
| | Delete Button | Delete the current image. |
| | AE Lock Button | Return to the parent view. For example: enter the 9 images view, select folders or storage to browse. When viewing one image and zooming in, press to zoom out on the image. |
| | AF Drive Button | Enter the subview. When viewing one image, press to zoom in on the image. |

Screen Switch

Switch between different screens using the gestures below.

Between Live View/Browse Mode and Control Screen: swipe down from the top and swipe up from the bottom.



Between Control Screen and Main Menu: swipe left and swipe right.

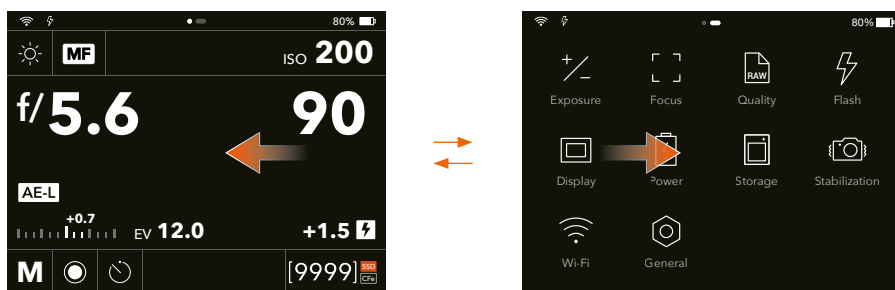

From Main Menu to Live View/Browse Mode: swipe up from the bottom. If Live View or Browse Mode is displayed before entering Main Menu, the display will return to the corresponding view from Main Menu after swiping up from the bottom.

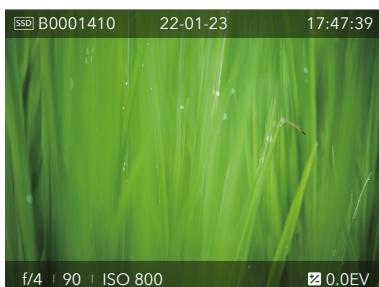
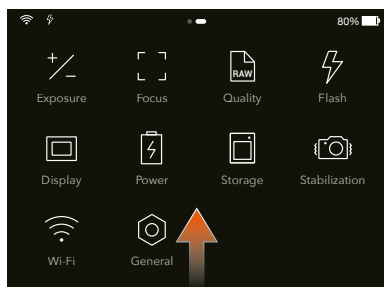
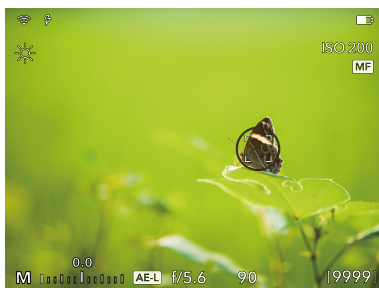
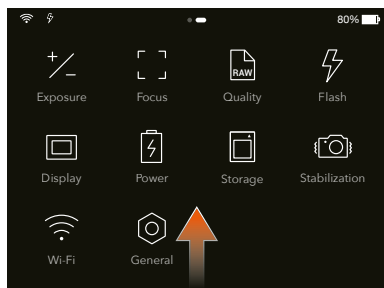

Live View

In any screen, half-press the shutter release button to enter Live View. Check the camera status and parameters, adjust some certain parameters, and take photos. Live View shows the exposure information by default. Press the circle button to the right of the touch display to switch between different information display, including:

Exposure Information

Exposure Information + Grid

Exposure Information + Distance Scale

Exposure Information + Spirit Level

None (image and focus area only)

Exposure Information Display

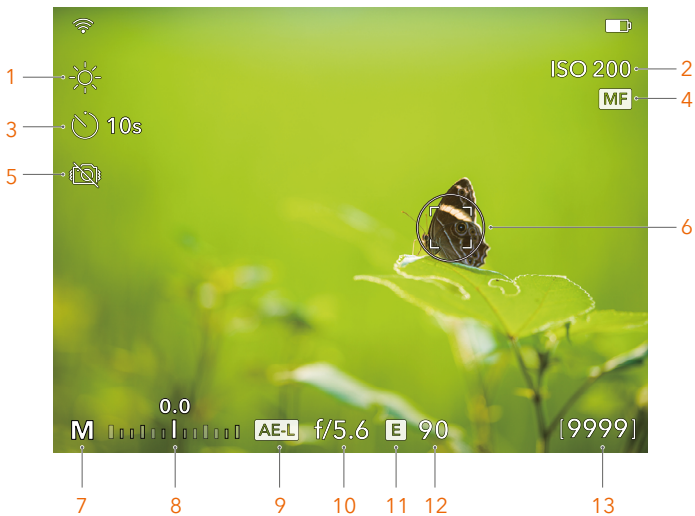

Users can go to Control Screen to adjust the camera parameters displayed in Live View. Refer to the Control Screen section for more information.

1. White Balance (WB)

There is no icon displayed when WB is set to Auto. Tap the area to open the option list. The settings are the same as WB on Control Screen. Refer to the Control Screen section for more information.

2. ISO

Tap to open the option list for ISO adjustment. Swipe on the touch display or toggle the front or rear scroll wheel to select from the list.

3. Drive Mode

There is no icon displayed when Single or Continuous Drive Mode is selected. When Self Timer, Interval, or Exposure Bracketing Drive Mode is selected, the corresponding icon will appear. Refer to the Drive Modes section for more information on instructions for each mode.

4. Focus Mode

There is no icon displayed when Autofocus (AF) is selected. Refer to the Focus Modes section for more information on instructions for each mode.

5. Image Stabilisation

There is no icon displayed when image stabilisation is enabled. This icon will appear when image stabilisation is disabled in the settings.

6. Focus Point

When Move Focus Point is enabled in the settings, users can tap the touch display to adjust the position of the focus point, or spread or pinch on the screen to change the focus point size. In Manual Focus Mode, the focus indicator will be displayed when Focus Indicator is selected in the MF Assist settings. Refer to the Focus Modes section for more information.

There will be a circle for spot metering around the focus point when exposure metering is set to Spot Metering.

7. Exposure Mode

8. Exposure Scale

Automatic Exposure Mode (A, S, P) displays the current exposure compensation. Manual Exposure Mode displays the value of light metering.

9. AE Lock (AE-L)

This icon will appear when AE-L is enabled.

10. Aperture

11. Electronic Shutter

This icon will appear when the electronic shutter is enabled in the settings.

12. Shutter Speed

13. Remaining Frames

A storage status icon will appear above the remaining frames when the camera is reading or writing data. The storage status of the memory card will also be displayed here. The descriptions of the icons are the same as those on Control Screen. Refer to the Control Screen section for more information.

Exposure Information + Grid Overlay



Exposure Information + Distance Scale Overlay

The arrow of the distance scale will move to the corresponding value when adjusting the focus distance.

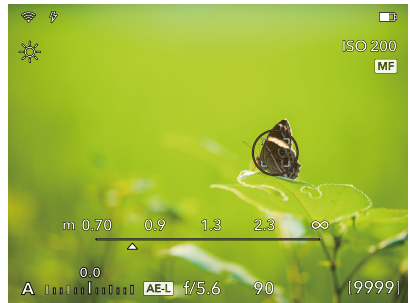

Exposure Information + Spirit Level Overlay

Observe the tilt of the camera in the horizontal and vertical directions to help adjust the camera position. Tap the upper left corner to calibrate the spirit level. Refer to the Spirit Level Calibration section for more information.

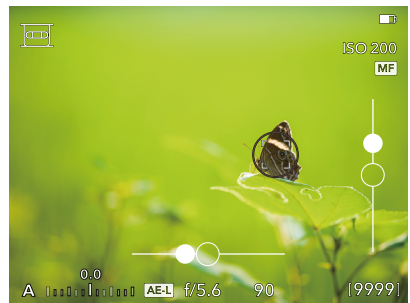

Control Screen

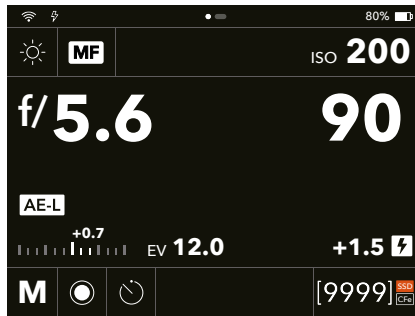

On Control Screen, view the current parameter settings and adjust. Tap the parameter requiring adjustment and change on Control Screen.

Enter/Exit Control Screen

Swipe down from the top of the touch display or press the menu button on the right of the touch display to enter Control Screen.

Swipe left on the touch display or press the menu button to exit Control Screen and enter Main Menu. Half-pressing the shutter release button can return to Live View.



When Control Screen is displayed, there is no ongoing light metering. The sensor is inactive to save battery power.

Locked Parameters on Control Screen

A Mode

In Aperture Priority (A), users can change the aperture value and the shutter speed value will be automatic and displayed in grey.

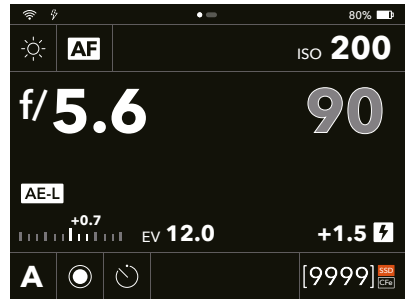

A Mode
Shutter speed is automatic.

S Mode

In Shutter Priority (S), users can change the shutter speed value and the aperture value will be automatic and displayed in grey.

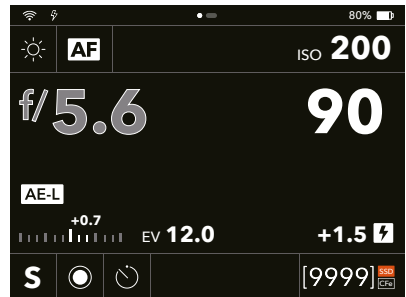

S Mode
Aperture is automatic.

P Mode

In P Mode, the aperture and shutter speed are automatic and displayed in grey indicating that users cannot change these settings. Use the front scroll wheel to shift aperture and shutter speed combination and rear scroll wheel to add an exposure adjustment.

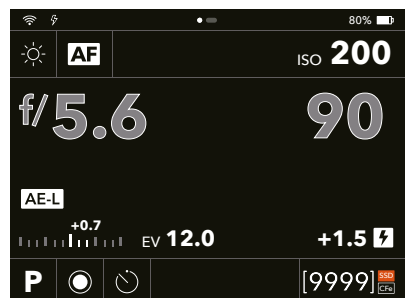

P Mode
Aperture and shutter speed are automatic.

Settings on Control Screen

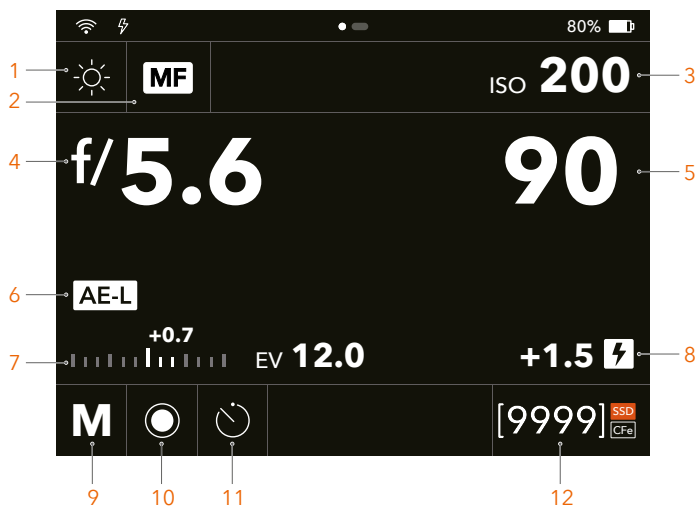

1. White Balance (WB)

Tap to enter the white balance mode list to select auto WB, preset WB, or manual WB. The colour temperature and tint values for each preset WB mode is shown in the table below.

If the preset modes cannot meet the requirements in some scenarios, users can adjust the temperature and tint values in the list on the right. In this case, the Manual WB Mode is automatically selected, and the adjustment will not affect the values in the preset WB modes.

| | Temp [°K] | Tint |
|-------------|------------------------|----------------------|
| Cloudy | 6500 | 10 |
| Shade | 7500 | 10 |
| Daylight | 5500 | 10 |
| Tungsten | 2850 | 0 |
| Fluorescent | 3800 | 21 |
| Flash | 5500 | 0 |
| Manual | Variable 2000 to 10000 | Variable -100 to 100 |



When working with a flash in situations where the subject is lit with different colour temperatures, it is recommended to set the camera to Auto WB.

2. Focus Mode

Includes AF and MF. Refer to the Focus Modes section for more information.

3. ISO

Select ISO value. Users can also select ISO value in Live View.

4. Aperture

5. Shutter Speed

6. AE Lock (AE-L)

This icon will appear when pressing the AE-L button to enable automatic exposure lock.

7. Exposure Scale and EV

Exposure scale is the same as in Live View. Automatic Exposure Mode (A, S, P) displays the current exposure compensation. Manual Exposure Mode displays the value of light metering. EV on the right side of the scale displays the current exposure value.

8. Flash Exposure Compensation

This icon will appear when a flash is mounted. Tap to set the flash exposure compensation.

9. Exposure Mode

Includes manual, aperture, shutter, program, and full auto. Refer to the Exposure Modes section for more information.

10. Exposure Metering

Includes centre weighted, spot, and centre spot.



Centre Weighted: used for light situations where there is no particular dominance of light or dark areas across the tonal range. This takes into account approximately 25% of the image seen in Live View.



Spot: the sensitive area is equivalent to approximately 2.5% of the image area (the central spot in Live View). Any parts of the image outside of this area will not affect the exposure reading. This provides a very accurate measurement of specific tones. Also suitable for tonal comparison measurements. Spot area is marked in Live View and will follow any movement of the focus point.



Centre Spot: emphasizes the central section of the focusing screen equivalent to approximately 25% of the image. This provides a balanced assessment and is a typical choice where the main subject is in the centre of the image.

11. Drive Mode



Includes single, continuous, self timer, interval, and exposure bracketing. View or set the shooting parameters for each mode on the right of the mode list. Refer to the Drive Modes section for more information.

12. Remaining Frames, Storage Location, and Storage Status





Remaining Frames: displays the number of photos that can be stored to the available storage according to the selected storage location and image format. When the secondary storage is used as backup in the Storage settings, the location with less

storage between the SSD and CFexpress memory card will be used to calculate the remaining frames.

Storage Location: displays the selected storage.

| | |
|---|---|
|  | Orange refers to the storage location in use. The primary slot and the backup secondary storage used will appear in orange. |
|  | A white border indicates extra storage that is set to overflow in the Storage settings. |
|  | When the CFexpress memory card is set to overflow but without any memory card inserted, the icon will display without a white border. |

Storage Status: displays the data writing status and error statuses. Includes:

| | |
|---|--|
|  | Current read write. This storage status icon will appear on the left of the remaining frames. |
|  | No memory card. This icon will appear when the secondary storage is set to backup but without any memory card inserted so that the camera cannot store images. |
|  | Memory card error. |
|  | Slow read/write speed. |

Browse Mode

Press the browse button to the right of the touch display to enter Browse Mode. View captured images and related information, rate the images, and delete images in Browse Mode. Browse Mode shows the standard information by default. Press the circle button to the right of the touch display or tap the bottom area on the touch display to switch between different information displays, including:

Standard

Capture Details + Image Rating

Separate Histogram RGB

Luminance Histogram

None (image only)

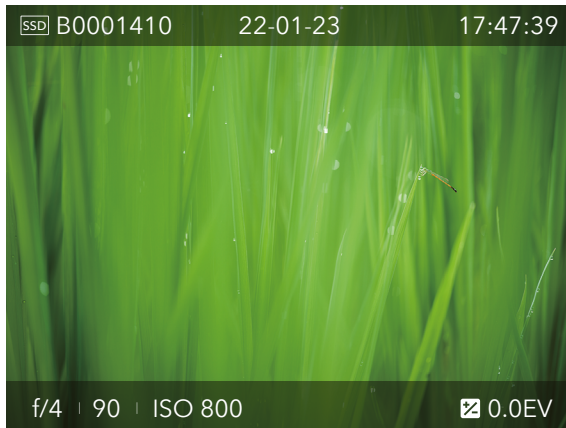

Refer to the Image Browsing section for more information.

2.4 TOP DISPLAY

The interface on the top display varies by the camera status and operating mode.

When the camera is powered off, press the ON/OFF button on the camera to show the battery level and charging status.

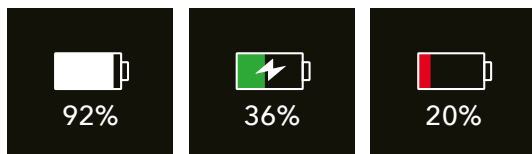

When the camera is powered on, the top display will show the camera settings such as ISO, aperture, shutter speed, exposure mode, white balance, remaining frames, storage status, and exposure compensation.

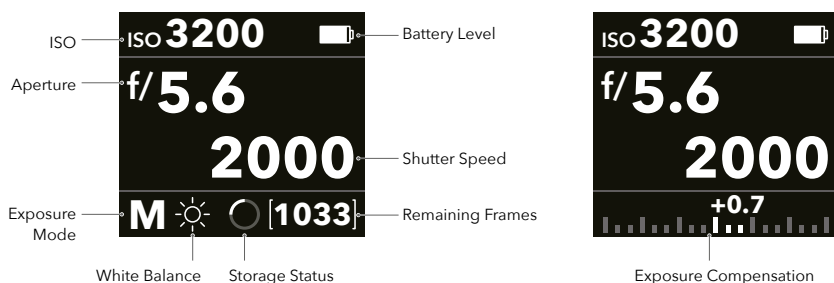

In specific drive modes, the top display shows information for the corresponding mode, such as countdown for Self Timer or photographing progress for Exposure Bracketing.



It shows the options when adjusting parameters.



It shows the status and error information, such as full storage or firmware update.



2.5 EXPOSURE MODES

The X2D 100C supports five exposure modes, including a manual mode and four automatic modes. Select the exposure mode using the exposure mode button or the settings on Control Screen.

| | |
|-------------|--|
| M | Manual Exposure Mode |
| A | Aperture Priority Automatic Mode |
| S | Shutter Priority Automatic Mode |
| P | Program Automatic Mode |
| AUTO | Full Automatic Mode (ISO and WB are automatically set) |

Selecting Exposure Mode

Using the button on the camera body: press the exposure mode button (when set to switching the exposure mode) and view the options on the touch display or top display. Toggle the front or rear scroll wheel to switch between options and press the exposure mode button or the rear scroll wheel to apply the mode.

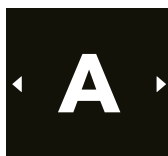

Using the touch display: on Control Screen, tap the exposure mode icon on the lower left corner and then tap on the pop-up menu to select the corresponding mode. Users can also use the front or rear scroll wheel to switch between options on the pop-up menu and press the rear scroll wheel to apply the mode.

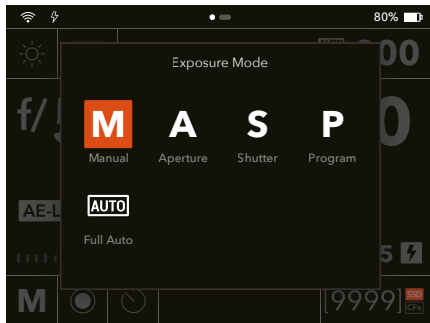
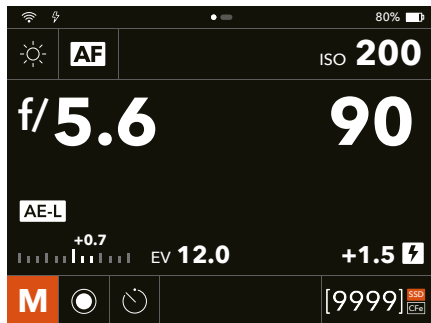

Manual Exposure

Manual Exposure Mode provides total control of the shutter and aperture settings. Toggle the front and rear scroll wheels to manually determine the aperture and shutter speed.

In Manual Exposure Mode, the exposure scale is displayed in Live View.

The standard exposure setting is obtained when the value displayed over the exposure scale is 0.0 and positioned above the central index.

The value appearing elsewhere than above the central index indicates the deviation from the standard exposure.

As shown in the figure, a “+ 0.7” above the scale in the display (A) indicates a “0.7 EV overexposure” setting. Conversely, a “-2”, for example, would indicate a “2 EV underexposure” setting. In Manual Exposure Mode, the aperture settings (B) and shutter speed (C) are conventionally indicated to the right of the exposure scale.

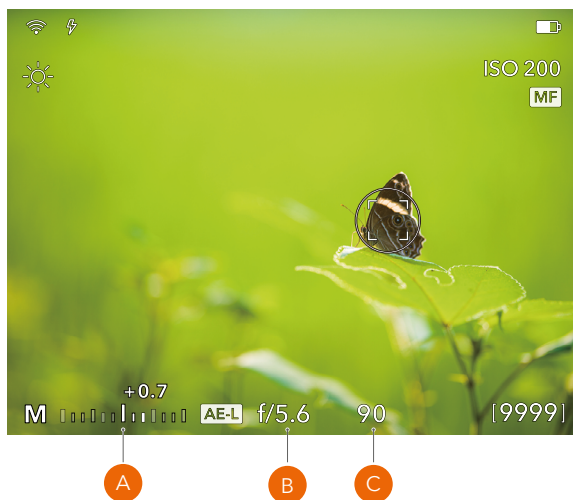

1 step, 1/2 step, or 1/3 step adjustment for the aperture value is also reflected on the display, according to the increment step size setting. For example, a setting between f/8 and f/11 will appear as f/9.5 if 1/2 step is selected.

Automatic Exposure

Automatic Exposure Mode includes three semi-automatic modes and one fully automatic mode for shutter speed and aperture control.

Aperture Priority (A)

Toggle the front scroll wheel to adjust the aperture. The shutter speed will be set automatically for optimal shooting performance.

Shutter Priority (S)

Toggle the front scroll wheel to adjust the shutter speed. The aperture will be set automatically for optimal shooting performance.

Program (P)

In this mode, the camera selects an aperture and shutter speed combination to suit various requirements and applications. The aperture and shutter speed have preset appropriate limitations according to the EV which is measured in a user-selected metering method. Users can shift the aperture and shutter speed combination using the front scroll wheel.

Full Auto (AUTO)

In this mode, ISO, aperture, and shutter speed are set by the camera automatically. No adjustments can be made except switching the focus mode. White balance is set to Auto, the metering method is Centre Weighted. Single, Continuous, and Self Timer Drive Modes are supported.



In P Mode, use the front scroll wheel to choose an appropriate aperture and shutter speed combination without changing the EV setting, and use the rear scroll wheel to adjust exposure compensation. The exposure scale and exposure compensation will be displayed in Live View or on Control Screen. Users can select whether to reset exposure compensation after shooting in the settings.

Auto Exposure Lock

In Live View, press the AE-L button to lock EV in Automatic Exposure Modes (A, S, P). In Manual Exposure Mode, press the button to lock the aperture and shutter speed combination. This allows users to shift the aperture and shutter speed combination using the scroll wheels without changing the exposure. AE lock is not supported in Full Auto Exposure Mode.

When the AE-L button is pressed, light metering is locked to the current EV setting. The AE-L icon appears to the left of the aperture value, indicating that the function is enabled. Press the button again to unlock.

In the locked setting, the aperture and shutter speed become interlocked. Users can choose a new aperture and shutter combination that still represents the same EV setting. For example, if the shutter speed is set to 1/125s and the aperture to f/8 with AE-L enabled, users can access new EV-equivalent combinations by toggling the front scroll wheel, such as 1/30s at f/16 or 1/500s at f/4.

In practice, position the metering area (for example, using spot metering) over an area equivalent to a mid-grey area and lock it with the AE-L button. Then recompose the picture with the metering area positioned over an area much brighter or darker while retaining the original exposure setting and choose a new combination of aperture and shutter speed settings.

2.6 FOCUS MODES

The X2D 100C supports autofocus (AF) and manual focus (MF). Select the focus mode using the focus mode button or the settings on Control Screen. When a lens with the push-pull focus ring is used, users can switch between AF and MF conveniently.

Selecting Focus Mode



When a lens with the push-pull focus ring is used, only MF is available when the focus ring is pushed to the front position. Users cannot select other focus modes.

In Live View, using the button on the camera body:

Press the focus mode button (when set to switching focus mode) to switch between AF and MF. The MF icon will appear on the right of the display, while no icon will appear in AF.

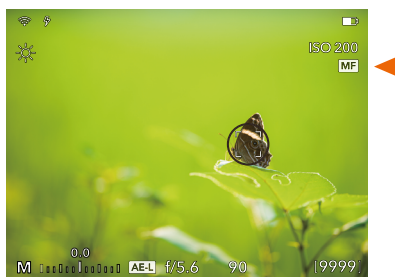

On Control Screen, using the button on the camera body or using the touch display:

Press the focus mode button (when set to switching focus mode) or tap the focus mode icon on the upper left corner of the screen. Tap the corresponding mode in the pop-up menu. Or toggle the front or rear scroll wheel to switch between options and press the focus mode button or the rear scroll wheel to apply the mode.



Using the push-pull focus ring:

When a lens with the push-pull focus ring is used, push the focus ring to the front position to enter MF. Pull the focus ring to the rear position to go back to the focus mode before entering MF. Refer to the corresponding lens manual for more information.

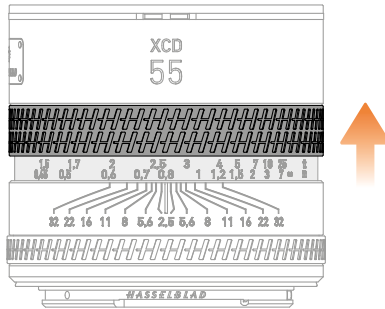

Auto Focus

Activate autofocus by half-pressing the shutter release button or pressing the AF-D button.

Focus is determined by the max contrast within the central marked area. When the contrast is not high enough, focus can not be set correctly.

The focus point display varies in different scenarios. See the illustrations here and the following descriptions.



Some H System lenses do not support AF. The camera will default to Manual Focus Mode for such lenses.

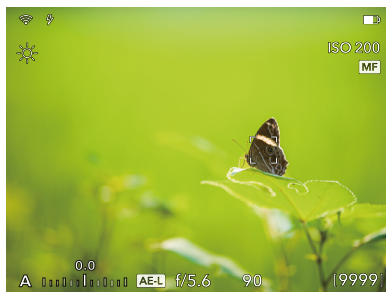

White focus point.

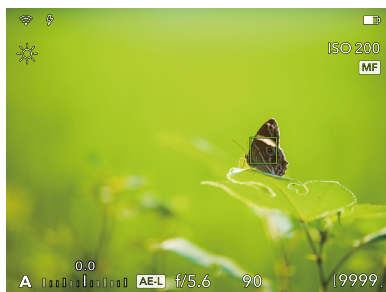

Green focus point. AF set correctly.



Red focus point. AF analysis failed to focus.

In AF, the shutter release will be locked until the camera finds the optimal focus setting to make sure that no images are made while not focused. The lock time is short in normal conditions. In good lighting conditions the camera will set the focus correctly in a short time.

Refer to the Manual Focus section for tips on using the manual and autofocus settings combined.

Focus Point

The square focus point in Live View indicates the status of the AF system. Activate autofocus by half-pressing the shutter release button or pressing the AF-D button.

Grey, white outline: normal. Autofocus is not analysing the subject. (1)

White, black outline: Autofocus is ongoing. (2)

Green: autofocus performed and focus is correctly set. (3)

Red: autofocus failed to focus and focus is not correctly set. (4)

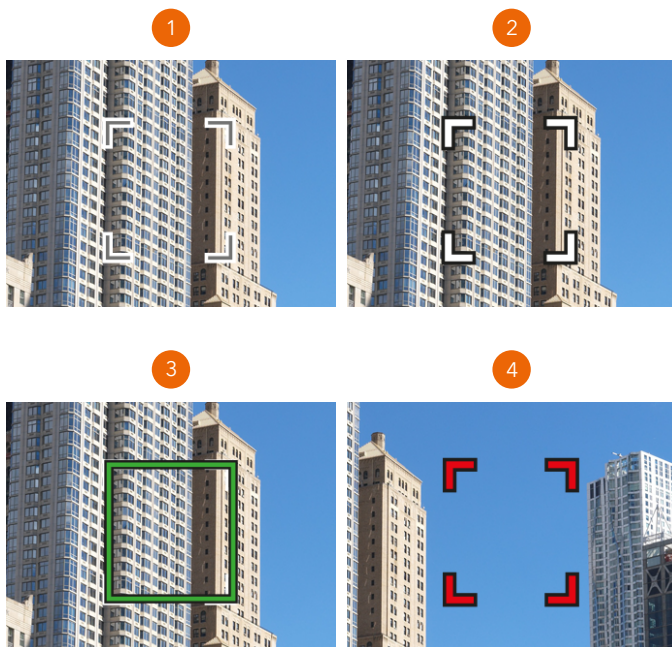

Users can adjust the focus point. Refer to the Moving and Adjusting Focus Point section for more information.

Autofocus Single

Half-press the shutter release button or press and hold the AF-D button to focus. Focusing will not restart if the camera or the subject moves.



- In this mode, the lens will focus at one distance and will remain focused at that distance while half-pressing and holding the shutter release button. In this way, users can focus on the subject, temporarily positioned within the focusing zone, and half-press and hold the shutter release button and recompose. As a result, the focus remains on the subject chosen even though it is now outside the focusing zone.
- For objects close to the camera and with wide-angle lenses, it is recommended to move the focus point into focus.

Manual Focus

Manual focus can be used at any time, even in Autofocus Mode. Users can also switch to Manual Focus Mode and use the focus ring manually on the lens only.

For users who prefer manual focus control but would like the benefits of autofocus, one method is to use the AF-D button for autofocus single. Align the focus point with the subject and press and hold the AF-D button. The camera uses the AF system to set the correct focus and reverts immediately to manual focus control when the button is released. In this case, users can recompose the picture. There is no need to hold the shutter release button to retain the autofocus setting.



AF-D is disabled when Manual Focus Mode is selected with the push-pull focus ring on the lens in the front position.

Manual Focus in Live View

1. Double-tap the touch display or press the rear scroll wheel (when set to zooming in) to zoom in on the image to 100% of the original size to check the focus area details.
2. Rotate the focus ring of the lens to focus.
3. Double-tap again to zoom out of the image to full image.

There are two focus assists for manual focus, Auto Zoom and Focus Indicator. Refer to the following section for more information.

If Auto Zoom is selected, the camera will automatically zoom in to 100% when rotating the focus ring. It will return to full image after a few seconds of inactivity.

Enabling MF Assist

Go to Main Menu > Focus > MF Assist, and then select Auto Zoom or Focus Indicator.



In Full Auto Exposure Mode, MF Assist is set to Focus Indicator when using Manual Focus Mode. Users cannot change the setting.

Auto Zoom

If enabled, the camera will automatically zoom in to 100% from where the focus point is located when rotating the focus ring. This makes it easy for the users to check whether the focus is set correctly on the subject or not.



Live View

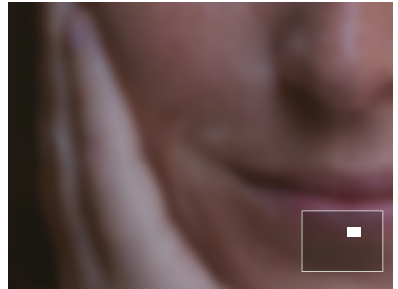

Auto Zoom to 100%. Subject not in focus.

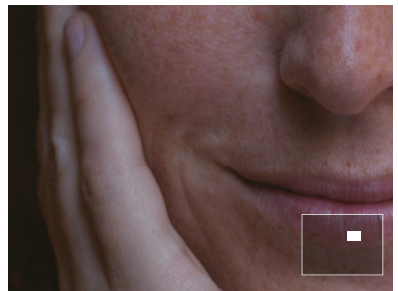

Auto Zoom to 100%. Focus set correctly.

Focus Indicator

If enabled, the focus indicator will appear in Live View.

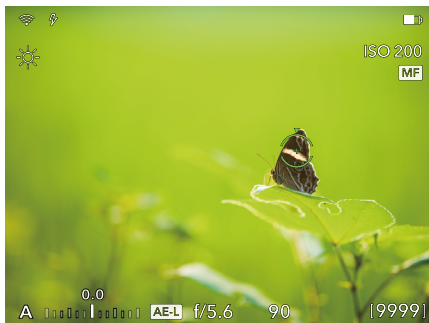

The focus indicator can indicate the relationship between the focus and subject and show the direction to rotate the focus ring.

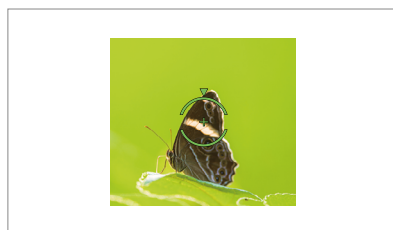
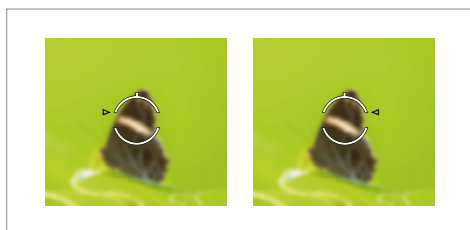

Grey triangle: the focus is too far from the subject. Users can try to rotate the focus ring clockwise or counterclockwise to make the triangle turn white.

Green triangle and circle: the focus is correctly set on the subject. Focus completed.

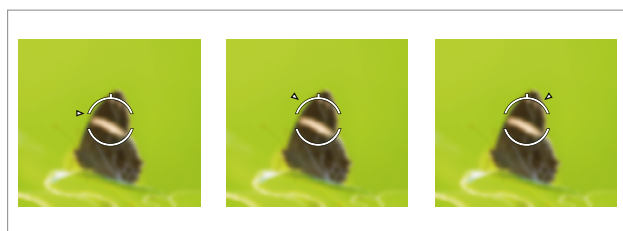

White triangle: the focus is close to the subject. Users can rotate the focus ring to focus. Rotate the focus ring clockwise when the triangle is located on the left of the focus indicator. Rotate the focus ring counterclockwise when the triangle is located on the right.

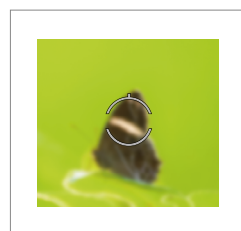

Grey circle: failed to focus.

Moving and Adjusting Focus Point

Users can move the focus point and adjust the focus point size while shooting. Make sure that Move AF Point is enabled before use. Follow the instructions below to set:

Go to Main Menu > Focus, scroll to the bottom, and then enable Move AF Point.

In Live View on the touch display, tap the display or swipe on the display to move the focus point to the target position. Spread or pinch to zoom in or out on the focus point. If EVF is used, the touch display can be used as a touchpad to move the focus point. Refer to the Electronic Viewfinder (EVF) section for more information.

In Live View on the touch display or in EVF, press and hold the focus mode button, and the focus point will change to a rectangle with arrows. In this mode, users can move the focus point or adjust the focus point size.

- Toggle the front scroll wheel to move the focus point left and right and the rear scroll wheel to move upward and downward.
- Press the circle button to the right of the touch display to adjust the focus point size to large or small.
- Press the delete button to the right of the touch display to reset the focus point to the centre of the screen.





After adjustment, press the focus mode button once to exit.



In Full Auto Exposure Mode, the focus point can only be moved using touch operations on the touch display. Users cannot adjust the focus point size. It is also unable to move the focus point by holding the focus mode button and using the scroll wheels.

2.7 DRIVE MODES

The X2D 100C supports drive modes including Single, Continuous, Self Timer, Interval, and Exposure Bracketing. Set on Control Screen.

| | |
|---|---------------------|
|  | Single |
|  | Continuous |
|  | Self Timer |
|  | Interval |
|  | Exposure Bracketing |

Selecting Drive Mode

On Control Screen, tap the drive mode icon at the bottom and tap on the pop-up menu to select the corresponding mode. Users can also use the front or rear scroll wheel to switch between options on the pop-up menu and press the rear scroll wheel to apply the mode.

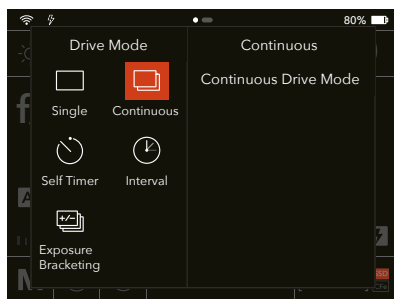
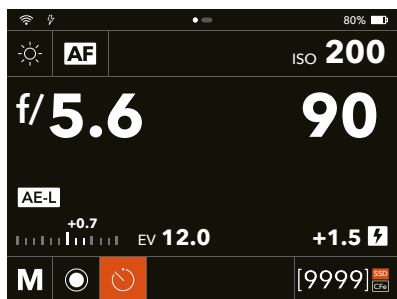

When Self Timer, Interval, or Exposure Bracketing is selected, the current configuration will be displayed to the right of the mode list.

Tap any of the parameters to enter the settings menu for adjustment. Users can also press the AF-D button on the camera body to enter the settings menu.

Tap the touch display or use the front and rear scroll wheels for adjustment. When completed, press the AE-L button to return to the mode list. Tap on the touch display or press the rear scroll wheel to apply the mode.

Single

In this mode, the camera will make one exposure only regardless of how long the shutter release button is pressed.

Continuous

The camera will make exposures as long as the shutter release button is pressed.

Self Timer

The camera will wait a preset time to make the exposure after the shutter release button is pressed.

Time: a delay between shutter release and exposure.

When Finished: determines if the function shall be active after a completed cycle or not. If set to Exit, the drive mode will be set to Single or Continuous automatically after exposure.

After the shutter release button is fully pressed, the touch display, EVF, and top display will show the countdown screen. The camera will take photos automatically after the preset countdown ends. Press the delete button to the right of the touch display to exit during the countdown.

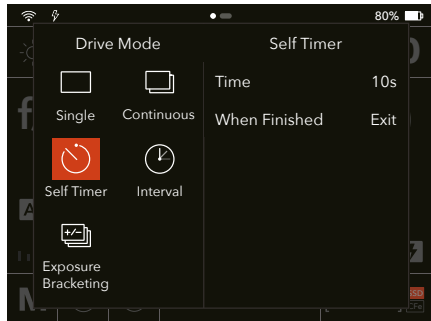

Interval

The camera will make a pre-determined number of exposures with a preset interval time.

Time: the time between exposures.

Frames: how many exposures will be made.

Initial Delay: a delay between shutter release and first exposure.

Metering: exposure metering for all frames or first frame only.

When Finished: determines if the function shall be active after a completed cycle or not.

Configure interval shooting parameters and press the shutter release button to start interval shooting. If Initial Delay is set, the camera will start a countdown before shooting the first image. Shooting will start after the preset delay ends.

The touch display, top display, and EVF will show information such as interval time countdown and shot frames/total frames during the sequence. Press the delete button to exit interval shooting if it is required to exit before completion.

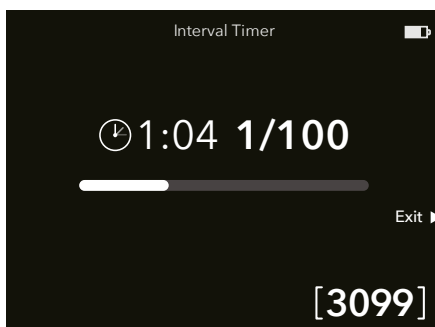
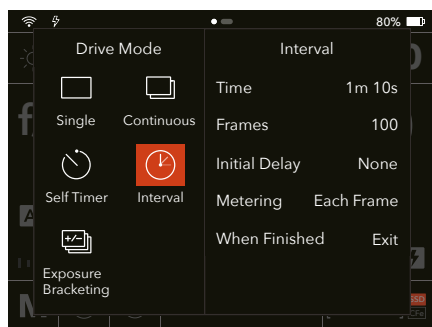

- Live View is disabled after interval shooting starts. If Preview is enabled in the Display settings, users can preview the previously shot image while shooting. The interval shooting information will display over the preview screen.
- When the interval time is set to 25s or more or the shutter speed is set to 1/6s or more, the camera will turn off the display to save battery 5 seconds after the shooting starts. The display will light up automatically before the next image is shot. Users can also wake up the display by pressing the ON/OFF button.
- Interval shooting on the camera is disabled when the camera is connected to the Phocus software on the computer or the Phocus Mobile 2 app on a mobile device. In this case, use the capture sequencer in Phocus to achieve interval shooting.

Exposure Bracketing

The camera will automatically make a pre-determined number of exposures with a preset exposure adjustment difference between each frame.

Amount: how much exposure difference between each exposure.

Frames: the number of exposures in the sequence.

Initial Delay: a delay between shutter release and first exposure.

Param in M: which of aperture or shutter speed to change if exposure bracketing is used in Manual Exposure Mode.

Sequence: the order to change the exposure compensation for each frame.

When Finished: determines if the function shall be active after a completed cycle or not.

Configure exposure bracketing parameters and press the shutter release button to start exposure bracketing. If Initial Delay is set, the camera will start a countdown before shooting the first image. Shooting will start after the preset delay ends.

The touch display, EVF, and top display will show information such as exposure compensation and shot frames/total frames during the sequence. Press the delete button to exit exposure bracketing if it is required to exit before completed.

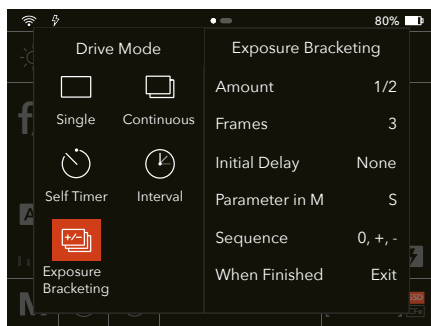

- Live View and Image Browsing are disabled after the exposure bracket starts.
- Light metering, focusing, and Auto WB is performed before the first exposure and applied to all images in sequence.
- When the shutter speed is set to 1/6s or more, the camera will turn off the display to save battery 5 seconds after shooting starts. The display will light up automatically before the next image is shot. Users can also wake up the display by pressing the ON/OFF button.
- Exposure bracketing on the camera is disabled when the camera is connected to the Phocus software on the computer or the Phocus Mobile 2 app on a mobile device. In this case, use the capture sequencer in Phocus to achieve exposure bracketing.

2.8 IMAGE STABILISATION

The X2D 100C features 5-axis 7-stop in-body image stabilisation (IBIS) to assist in capturing crisp handheld shots.

Enable or disable image stabilisation in Main Menu > Image Stabilisation settings.  will appear on the left side in Live View when disabled.



- Disable image stabilisation when using a tripod. Otherwise, the image quality will be adversely affected.
- Image stabilisation is not supported when using some of the H System lenses. Make sure to disable image stabilisation to avoid a decrease in image quality when a hint for not supported lens appears in the settings screen.

2.9 BUILT-IN SSD

The X2D 100C has a built-in 1TB SSD to store images. Connect the camera to a computer to use the built-in SSD as mass storage for data read/write.

Storing Files to SSD

Go to Main Menu > Storage > Primary Slot, and select SSD. Check the free space of the SSD in the Info section.

Formatting SSD





Formatting SSD will erase all the contents on the SSD. Operate with caution.

1. In the Storage settings, scroll to the bottom and select Format SSD.
2. Press the circle button to the right of the touch display to perform formatting.
3. Wait for formatting to be completed.

Checking SSD Storage Status

Check the SSD storage status on Control Screen or the top display.

Using the SSD as Mass Storage

1. Connect camera to a computer using a USB-C cable of USB 2.0 or above.
2. Tap Mass Storage in the pop-up dialogue on the camera touch display.  will be shown on the touch display while  will be shown on the top display.
3. The camera SSD will be connected to the computer as a mobile storage device and data read/write to the SSD is available.



After the camera is connected to the computer, if Skip is selected on the touch display, the built-in SSD will not be connected to the computer. Reconnect the camera to the computer and select the correct option.

2.10 MEMORY CARDS

Insert a CFexpress Type B memory card to expand storage. Memory cards with storage of up to 512GB are supported.

Recommended Memory Cards

It is recommended to use the following CFexpress Type B memory cards for the optimal storage experience.

Sony CEB-G series CFexpress Type B memory cards (128GB).

SanDisk Extreme Pro CFexpress Type B memory cards (128GB, 256GB, 512GB).

Storing Files to Memory Card

Go to Main Menu > Storage > Primary Slot, and then select CFe. Check the free space of the CFexpress memory card in the Info section.

Formatting Memory Card



- It is recommended to format the memory card on the camera before using it for the first time.
- Formatting the memory card will erase all the contents on the memory card. Operate with caution.

1. In the Storage settings, scroll to the bottom and select Format CFe.
2. Press the circle button to the right of the touch display to perform formatting.
3. Wait for formatting to be completed.

Checking Memory Card Storage Status

Check the memory card storage status on Control Screen or the top display.

2.1.1 ELECTRONIC VIEWFINDER (EVF)

Make sure that EVF-Rear Screen is selected to Auto or EVF Only in the Display settings in Main Menu. EVF will be activated when approaching the EVF. Like the touch display, the EVF also has Live View, Control Screen, Main Menu, and Browse Mode. Users can take photos, view the camera status, set parameters, and browse files on different screens. Use the buttons on the camera body to switch between screens rather than swiping on the touch display.

When using EVF, the touch display can be used as a touchpad. Gestures on the touchpad are available to move the focus point and zoom in or out on the images.

Screen Display

The Live View display in EVF is the same display as the touch display. Press the circle button on the camera body to switch between different information display.

Swipe on the area preset for the touchpad to move the focus point when Move AF Point is enabled in the settings. See the following section.

The Control Screen display in EVF is the same as on the touch display. Set parameters using the buttons and scroll wheels on the camera body rather than the touchpad.

The Browse Mode display in EVF is the same display as the touch display. Press the circle button on the camera body to switch between different information on the display. Tap the touchpad to show or hide the information displayed on the current image. The image rating is disabled.

Dioptr Adjustment

The X2D 100C EVF supports electronic dioptr adjustment. Try adjusting the dioptr in the settings when the EVF display is not clear. Refer to the Display Settings section for more information.

Touchpad Operations

When using the touchpad in Live View, only operations in the preset area on the touchpad will work. The descriptions below introduce touchpad area settings and operations in Live View.

Setting Touchpad Area

The area depends on which eye is used when looking through the EVF. For example, if the right eye is used, it is recommended to set it as Right. This will use the right half of the touch display as a touchpad.

Follow the instructions below to set:

Go to Main Menu > General > Touch, and then select the touchpad area and sensitivity.

Moving Focus Point

Swipe on the preset touchpad area and observe the movement of the focus point in EVF. Make sure that Move AF Point for EVF is enabled before use. Follow the instructions below to set:

Go to Main Menu > Focus, scroll to the bottom, and enable Move AF Point for EVF.

Zooming In/Out

Double-tap the preset touchpad area to zoom in to 100%. Double-tap again to zoom out to the full image.

2.1.2 IMAGE BROWSING

Browse and manage images on the touch display or in EVF. The following descriptions use the touch display as an example. Unless otherwise specified, EVF has the same operations.

Browse Mode includes four menu levels:

- Standard Preview
- 9 View
- Folder Browsing
- Storage Location

The camera enters Standard Preview Mode by default. Press the AE-L button or toggle the rear scroll wheel to the left to enter the upper level. Press the AF-D button or toggle the rear scroll wheel to the right to enter the lower level.

Browsing Images

Press the browse button to the right of the touch display to enter Browse Mode.

When Preview is enabled in the settings, the camera will enter Browse Mode after shooting is finished. Follow the instructions below to set:

Go to Main Menu > Display, scroll to the bottom, select the preview time, and enable Rear Screen or EVF in the Preview section.

Use the front scroll wheel or swipe on the touch display to switch the image to browse.

Spread or pinch on the touch display to zoom in or out. Double-tap the touch display to zoom in to 100% or zoom out to full image.

Press the circle button to switch the information overlay.

Press the delete button to delete the image currently displayed.



When browsing images in EVF, users are unable to swipe, spread, or pinch on the touchpad. Users can double-tap on the touchpad to zoom in or out on the image.

Standard Preview Mode

The camera displays Standard Preview Mode when entering Browsing Mode. Users can view the captured images and basic settings in Standard Preview Mode.

Besides basic settings, Standard Preview Mode also includes information overlays below: Capture Details Mode, Separate Histogram RGB Mode, and Luminance Histogram Mode. Refer to the related section for more information.

1. Storage Location (SSD or CFe)
2. Capture Date
3. Capture Time
4. Aperture (f/4)
5. Shutter Speed (90)
6. ISO Setting (800)
7. Exposure Adjustment Indicator and Exposure Compensation Value (0.0 EV)

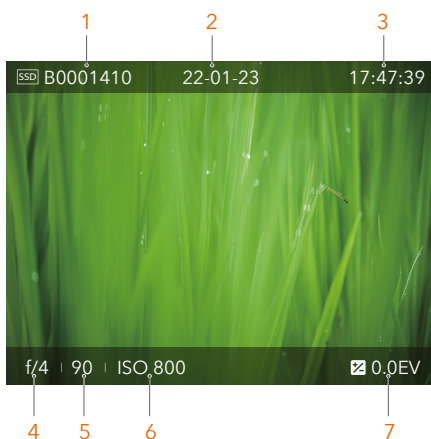

9 View Mode

In Standard Preview Mode, pinch on the touch display, press the AE-L button, or toggle the rear scroll wheel to the left to enter 9 View Mode. In this mode, users can preview nine images on the screen. Scroll on the touch display to preview other images when the number of images is more than nine. Select an image to view details.



Capture Details Mode

The Capture Details Mode displays the detailed information when captured.



Separate Histogram RGB Mode

In Separate Histogram RGB Mode, the individual RGB channels are displayed. The Red R channel first, the Green G channel in the middle, and the Blue B channel below the Red and Green channels.

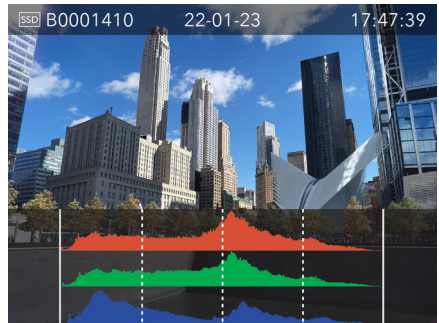

Luminance Histogram Mode

The Luminance Histogram Mode displays the luminosity. The luminance is represented by a White Graph.

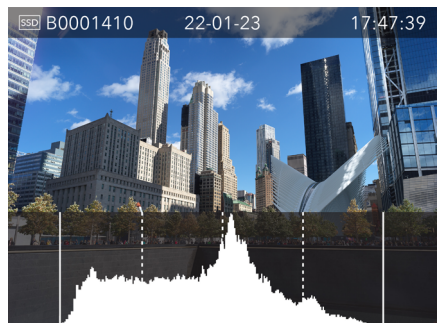

Luminance Histogram Exposure

The histogram provides a graph that indicates the total number of pixels at each brightness level, with brightness in range from black on the left to white on the right. It is a valuable tool for evaluating images.

A well exposed shot usually has a full range of levels, while underexposed and overexposed images tend to show levels concentrated at the left or right part of the scale.

The histogram is only an indicator that should be interpreted. There are several situations in which a 'bad' histogram will match an exposure that could be perfect for the intended effect.

Study the histogram examples and the explanations below.

Underexposure

Histogram display concentrated on the left with few pixels elsewhere indicates a likely underexposure. Many details will be lost in the shadows.

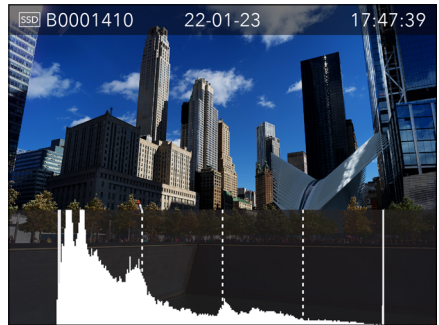

Underexposure

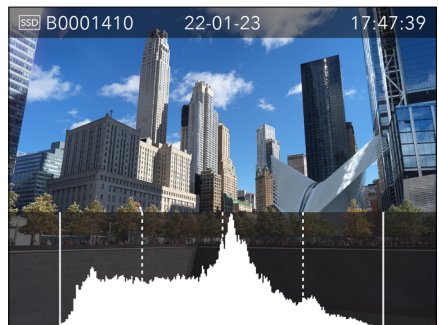

Even exposure

Overexposure

Histogram display spread across the full range indicates a likely good exposure. There may still be a few pixels at the extremes, indicating a few spectral highlights and saturated shadows, but this is often normal in a good exposure.

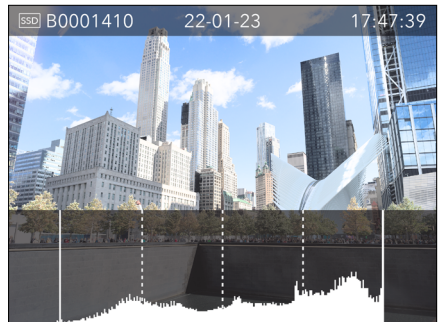

Overexposure

Overexposure

Histogram display concentrated on the right with few pixels elsewhere indicates a likely overexposure. Many details will be lost in the highlights.

Selecting Folder to Browse

1. Enter 9 View Mode, Folder Browsing, and Storage Location successively from Standard Preview Mode.
2. Select SSD or CFexpress to browse.
3. Enter Folder Browsing Mode. Toggle the front scroll wheel to switch between folders and press the AF-D button or toggle the rear scroll wheel to enter the folder.
4. Enter 9 View Mode and Standard Preview Mode successively to preview the images.

Creating Folders

1. Enter 9 View Mode, Folder Browsing, and Storage Location successively from Standard Preview Mode.
2. Select SSD or CFexpress to browse. Folders can only be created in the storage set as the primary slot.
3. Enter Folder Browsing Mode and tap the icon on the upper right corner of the touch display to create a folder. Users can also toggle the front scroll wheel to select the icon and press the AE-L button or the rear scroll wheel to confirm.
4. Press the circle button to the right of the touch display to create a folder, or press the delete button to exit.

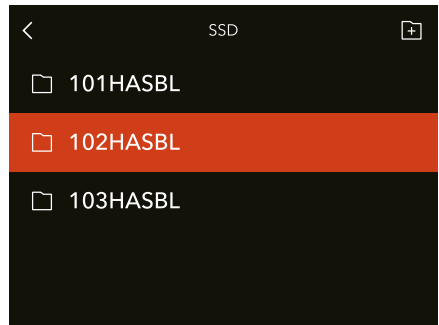

- The name of the folder is generated by the system and cannot be changed. New images will automatically be stored in the new folder.
- When the secondary storage is set to backup, after a new folder is created in the primary slot and an image is captured, the system will create the same folder in the secondary storage to back up the captured images.

Image Rating

Images can be rated from 1 to 5 stars when browsing. The rating is written to the meta-data of the image file.

1. Enter Standard Preview Mode.
2. Press the circle button until image details are displayed. The five stars show the current rating in the lower right corner of the touch display. For an unrated image, no stars are filled.
3. To rate the image, tap the five stars.
4. The camera enters Rating Mode, showing five stars. If the image has been rated before, it will show the current rating. Otherwise, the five stars will be empty.
5. Tap the desired star to change the rating. For example, tap the fourth star to score a 4-star rating. The circle button increases the rating and the delete button decreases the rating. Users can also use the rear scroll wheel to change the rating.
6. Press the browse button to save ratings and return to Standard Preview Mode.

In Rating Mode, users can swipe left or right on the touch display or toggle the front scroll wheel to switch between images.

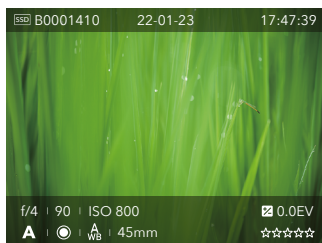

Browse Mode - Capture Details Overlay

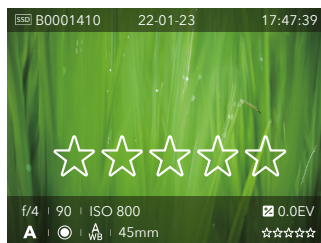

Rating Mode - Unrated

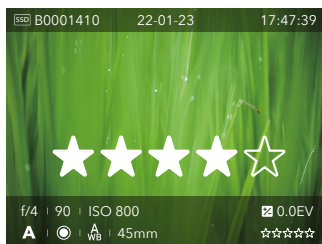

Rating Mode - Rated 4 stars

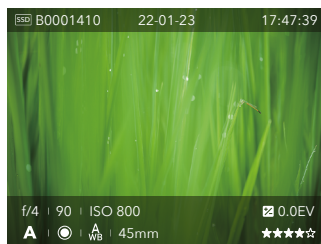

Browse Mode - Rated 4 stars



For an efficient workflow while rating multiple images, stay in Rating Mode and switch to the next or previous image.

3 SETTINGS

3.1 MAIN MENU

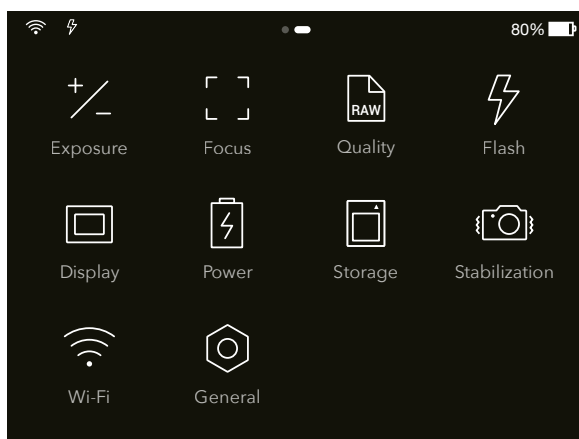

In Live View, press the menu button to the right of the touch display twice to enter the main menu.

On Control Screen, press the menu button once or swipe left on the screen to enter the main menu.

Main Menu includes frequently used settings such as Exposure, Focus, Quality, Flash, Display, Power, Storage, Stabilisation, Wi-Fi, and General Settings.

Tap on the screen to enter the settings menu. Swipe right in a sub-menu to return to the previous screen. Users can also use the buttons and scroll wheels on the camera body to set parameters. Refer to the Touch Display Operations section.



The adjustable parameters vary depending on the exposure mode and lens in use. Parameters that cannot be adjusted will be displayed in a grey colour.

3.2 EXPOSURE SETTINGS

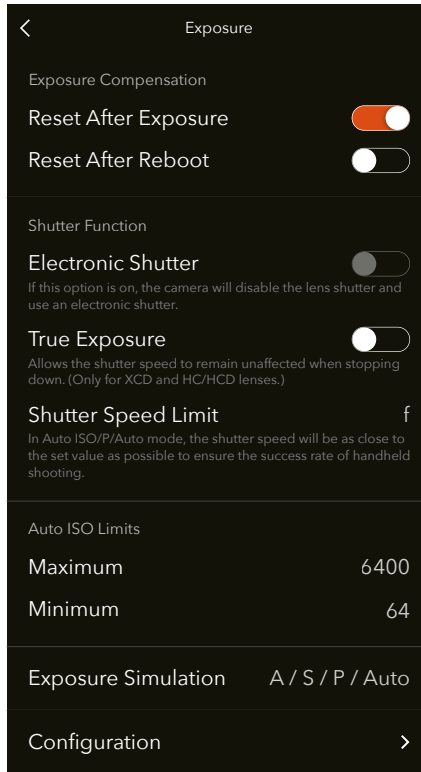

Exposure Compensation

Main Menu > Exposure > Exposure Compensation

Reset After Exposure

Reset the exposure compensation and AE-L status after capture or the last exposure in a series.

Reset After Reboot

Reset the exposure compensation and AE-L status after powering on the camera.

Shutter Function

Main Menu > Exposure > Shutter Function

Electronic Shutter

Select On or Off. When electronic shutter is enabled, the camera will disable the lens shutter and use an electronic shutter in the sensor instead. Electronic shutter is indicated with an E symbol in front of the shutter speed in Live View and on Control Screen.

Note the following limitations with electronic shutter:

- The electronic shutter may not capture a subject clearly with fast movements or when shooting handheld. It is recommended to capture a stationary subject or using a tripod.
- It is recommended to use the mechanical shutter to ensure image quality when ISO 6400 or above is set.
- Shutter speed range is 68 min to 1/6000s.
- Flash is disabled.
- True exposure is disabled.

True Exposure

Select On or Off.

Determines whether the exposure is automatically adjusted to create a true exposure setting. On allows the adjustment. Off retains the normal setting.



- If using flash/strobe as the main light source and 1/800s or shorter shutter speed (depending on lens type), make sure to disable true exposure.
- The true exposure feature is designed to keep the shutter speed unaffected by the aperture value.

True Exposure Explained

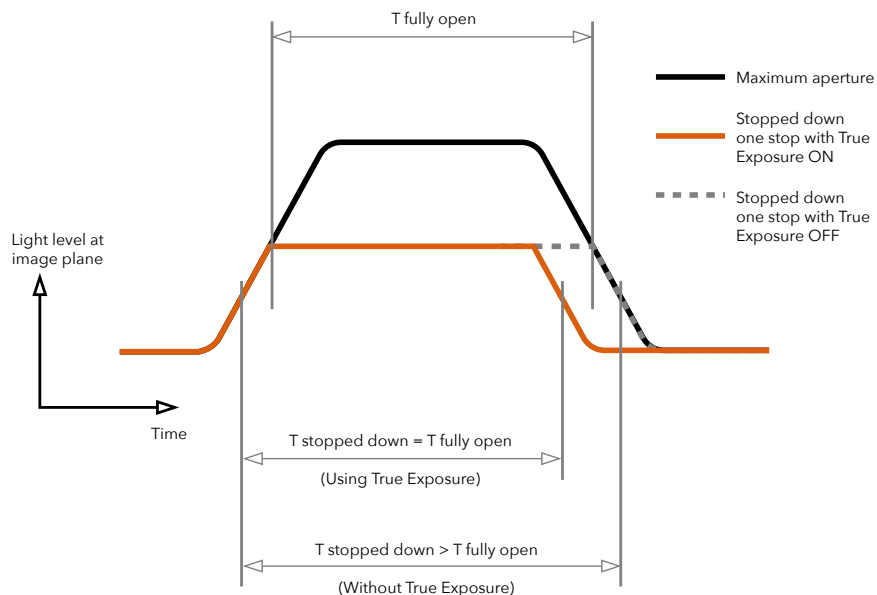

True Exposure is an XCD and HC/HCD lens function that allows the shutter speed to remain unaffected when stopping down. This effect is perhaps not so commonly understood as it is restricted specifically to integral lens shutters as opposed to focal plane shutters.

When a lens is stopped down, the effective shutter speed becomes longer, consequently affecting the set exposure. At slow shutter speeds the effect is minimal but at faster speeds, e.g. 1/500s, the effect becomes clearly visible. Automatic compensatory measures in speed setting adjustments are employed.

As compensation can only be put into effect where speeds can be adjusted, this prevents the possibility of adjusting the fastest speed. To counter this, compensatory adjustments are therefore made to the aperture instead to retain the set exposure. This compensation is not always required and when using flash/strobe as the main light source it is actually undesirable because compensation will result in underexposure. Therefore, when using flash/strobe as the main light source, disable true exposure in Main Menu > Exposure > True Exposure on the touch display.

Download a complete explanation of this situation from www.hasselblad.com.

Shutter Speed Limit

The shutter speed limit can be set either directly or as a function of focal length.

For example, when a 45mm lens is in use and the Shutter Speed Limit setting is 2f, the shutter speed limit will be 1/90s.

In Auto ISO/P/Full Auto Mode, the shutter speed will be as close to the set value as possible to ensure the success rate of handheld shooting.

Auto ISO: sets the slowest shutter speed before ISO will be increased.

P: if the calculated shutter speed is slower than the set value, the aperture value will be changed instead of shutter speed.

Full Auto: if the calculated shutter speed is slower than the set value, the aperture value will be changed instead of shutter speed.



The shutter speed limit can still be exceeded in some cases. For example, if using A Mode and the maximum ISO limit is already reached and there is not enough light, the shutter speed limit will be exceeded as a last resort to get a proper exposure.

Auto ISO Limits

Main Menu > Exposure > Auto ISO Limits

Set the maximum and minimum ISO values for when Auto ISO is set.

After configuration, when ISO is set to Auto in A, S, or P Exposure Mode, the ISO is set automatically by the camera. It is unable to exceed these maximum and minimum limits.

Exposure Simulation

Main Menu > Exposure > Exposure Simulation

In Live View on the touch display or in EVF, the display will simulate the final image exposure. Select A/S/P/Auto or A/S/P/Auto/M to enable the function in the corresponding exposure mode.



- Exposure Simulation will not display a correct result when using the camera with a flash. For example, when shooting with a flashlight indoors, normally, Exposure Simulation displays an image that is too dark in Live View due to weak light conditions. It is recommended to disable Exposure Simulation in Manual Exposure Mode before shooting with a flash.
- When autofocus is enabled and is analysing the subject, Exposure Simulation is deactivated to let the autofocus system operate in optimal conditions. When the autofocus process is completed, Exposure Simulation is automatically activated again.
- When using Exposure Simulation with the exposure settings set to very high overexposure or very low underexposure for the actual light conditions, Live View will display a very light or very dark image. In extreme cases, it results in a completely overexposed white image or a completely underexposed black image. In these cases, check the exposure scale on the bottom left in Live View while adjusting the exposure settings to maintain desired exposure.

Configuration

Main Menu > Exposure > Configuration



Exposure Lock

Out of Range

If enabled, it is not able to make an exposure after pressing the shutter release button when the aperture or shutter speed is out of range.

Increment Step Size

Exposure

Select the step size when adjusting the exposure for a single step. Options are 1 step, 1/2 step, and 1/3 step.

Exposure Adjustment

Select the step size when adjusting the exposure compensation for a single step. Options are 1 step, 1/2 step, and 1/3 step.

B/T Mode

Show B/T Mode

If enabled, B and T will appear next to 1.0s in the shutter speed list in Manual Exposure Mode.

To capture images when B Mode is selected, press and hold the shutter release button until exposure ends.

To capture images when T Mode is selected, press the shutter release button once to start capture and release, and press the shutter release button again or Exit when exposure ends.

Lens

Max Aperture

Select to use a fully open round aperture or a normal aperture at the maximum setting.

Full: a fully open round aperture. For XCD lenses only.

Normal: standard setting. This can minimise the risk of internal reflections.

Using the XCD 90 lens as an example, the Normal setting can cause a polygonal look for the out-of-focus areas, while the Full setting will create a smoother and round look for the out-of-focus areas with all the leaves fully open.



Image detail with Normal setting



Image detail with Full setting



Normal



Full

3.3 FOCUS SETTINGS

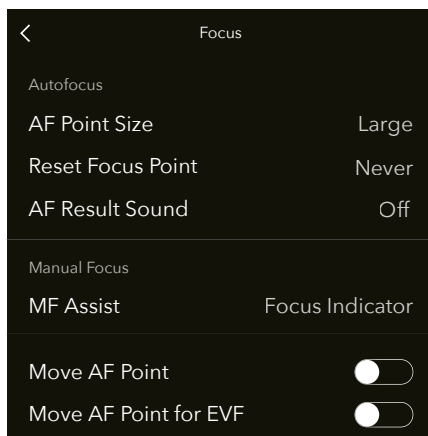

Autofocus

Main Menu > Focus > Autofocus

AF Point Size

Select the focus point size displayed in Live View between large and small. The number of focus points varies depending on the focus point size.

Users can also adjust the focus point size in Live View. Refer to the Moving and Adjusting Focus Point section.

Reset Focus Point

Set whether to reset the focus point to the centre of the screen after each exposure.

Select Never if it is required to fix the focus point in a certain location.

AF Results Sound

Select the sound for a failed or successful focusing result between Low, Medium, and High.

Users can also turn off the sound by selecting Off.

Manual Focus

Main Menu > Focus > Manual Focus

MF Assist

Select from the following method for MF assist in Manual Focus Mode.

Auto Zoom: the camera will zoom in to 100% automatically when rotating the focus ring in Manual Focus Mode. Refer to Auto Zoom in the Manual Focus section for more information.

Focus Indicator: in Manual Focus Mode, the focus point will display as a focus indicator to indicate whether the focus is correctly set. Refer to the Focus Indicator section for more information.

None: no MF assist.

Move AF Point

Main Menu > Focus > Move AF Point

If enabled, users can adjust the focus point position and size in Live View on the touch display. Refer to the Moving and Adjusting Focus Point section for more information.

Move AF Point for EVF

Main Menu > Focus > Move AF Point for EVF

If enabled, users can adjust the focus point position and size when EVF is used. Refer to the Moving and Adjusting Focus Point section for more information.

3.4 QUALITY SETTINGS

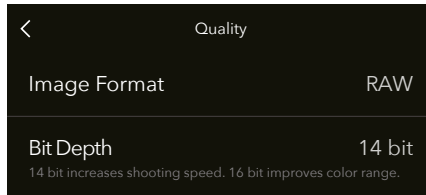

Image Format

Main Menu > Quality > Image Format

Select the format of the still images between RAW, RAW+JPG, and JPG.

Bit Depth

Main Menu > Quality > Bit Depth

When the image format is selected to RAW or RAW+JPG, select the colour depth of the images between 14 bit and 16 bit.

Using 16 bit, the camera can acquire most information for the image and restore more details with less noise, which is convenient for users to perform post-processing and creation.

Using 14 bit, users can experience faster capture and decreased blackout time between shots.

Files for both two settings have the same size in storage.

3.5 FLASH SETTINGS

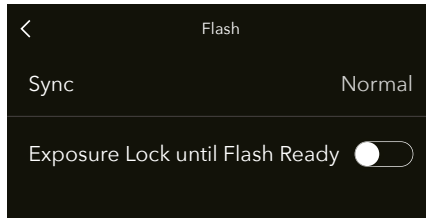

Sync

Main Menu > Flash > Sync

Set to trigger the flash at the beginning or end of the exposure.

Normal: to trigger at the beginning of the exposure.

Rear: to trigger at the end of the exposure.

Exposure Lock until Flash Ready

Main Menu > Flash > Exposure Lock until Flash Ready

Set whether to block a capture if the flash is not ready. If enabled, the capture will be blocked. While disabled, the capture will be allowed.

3.6 DISPLAY SETTINGS

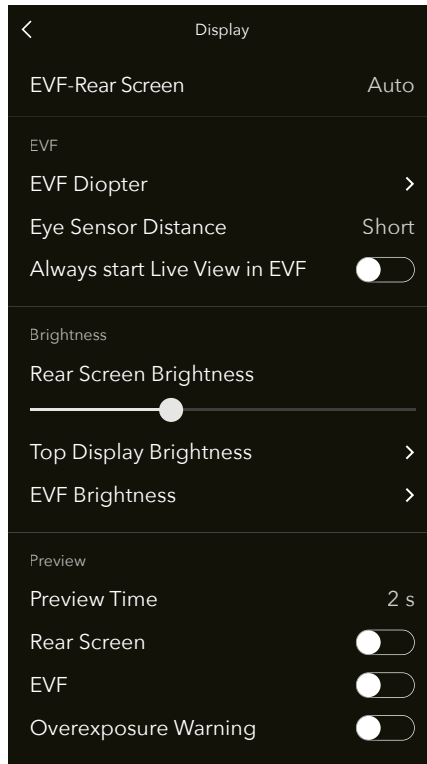

EVF-Rear Screen

Main Menu > Display > EVF-Rear Screen

Set to use the rear touch display or EVF for display.

Auto: the touch display will be used for display when not approaching the eye sensor. The EVF will be activated when an eye approaches the eye sensor.

Rear Screen Only: the touch display will only be used. The EVF will not be used in any scenarios.

EVF Only: the EVF will be used only. The touch display will not be used in any scenarios. In this case, the EVF is always active even though the user is not approaching the eye sensor.

EVF

Main Menu > Display > EVF

EVF Dioptre

Tap to enter adjustment. Look through the EVF and toggle the front and rear scroll wheels to adjust the dioptre to an appropriate setting. Press the rear scroll wheel or tap Exit on the touch display to complete the adjustment.

Eye Sensor Distance

Select the sensitivity of the eye sensor for the EVF from Short or Normal.

Always start Live View in EVF

If enabled, when switching from the touch display to EVF, the EVF will always display Live View. If disabled, the EVF display will keep the same as the touch display. For example, if the touch display is in Main Menu, the EVF will also display Main Menu when looking through the EVF.

Brightness

Main Menu > Display > Brightness

Rear Screen Brightness

Slide the slider to adjust the brightness of the touch display.

Top Display Brightness

Tap to enter adjustment. Toggle the front and rear scroll wheel to adjust the brightness and check on the top display. Press the rear scroll wheel or tap Exit on the touch display to complete the adjustment.

EVF Brightness

Tap to enter adjustment. Look through the EVF and toggle the front and rear scroll wheels to adjust the brightness. Press the rear scroll wheel or tap Exit on the touch display to complete the adjustment.

Preview

Main Menu > Display > Preview

Set the preview time and enable the touch display or EVF preview to preview the latest captured image after exposure ends.

Preview Time

When it is set to 0.5s, 1s, 2s, 4s, or 8s, the display will return to Live View after the preset time.

When it is set to Hold, the display will stay in Browse Mode until users change to a different screen.

Rear Screen

If enabled, the display will switch to preview after shooting in Live View on the touch display.

EVF

If enabled, the display will switch to preview after shooting in Live View in the EVF.

Overexposure Warning

If enabled during preview, the overexposure areas in the image will flash as an indication.

3.7 POWER SETTINGS



Display Off

Main Menu > Power > Display Off

The display will be off if no operation is performed on the camera within the display-off time.

Power Off

Main Menu > Power > Power Off

The camera will power off automatically if no operation is performed on the camera within this power-off time. If Never is selected, the camera will stay powered on.

Power Off when Tethered

Main Menu > Power > Power Off when Tethered

When powering the camera using a USB-C cable, the camera will power off automatically if no operation is performed on the camera within this preset time. If Never is selected, the camera will stay powered on.

3.8 STORAGE SETTINGS

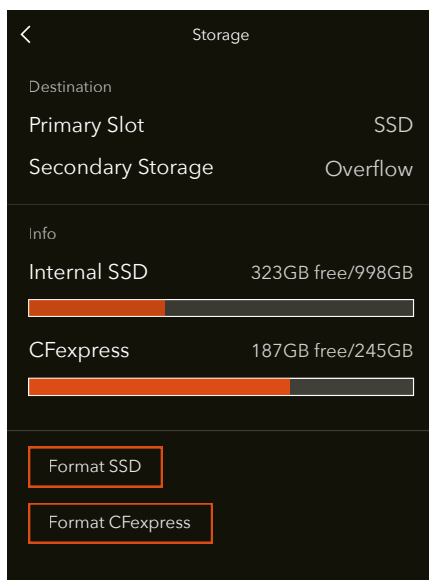

Destination

Main Menu > Storage > Destination

Set usage for the built-in SSD and CFexpress memory card.

Primary Slot

Select SSD or CFe as the primary storage and the other one as the secondary storage.

Secondary Storage

If Overflow is selected, the camera will store images in the secondary storage when the preset primary storage is full.

If Backup (Images) is selected, the camera will store images to both the primary and secondary storage simultaneously.

Info

Main Menu > Storage > Info

Displays the volume and available space of the built-in SSD and the CFexpress memory card inserted.

Format

Main Menu > Storage > Format SSD

Tap to format the built-in SSD.

Main Menu > Storage > Format CFe

Tap to format the inserted memory card.



Formatting will erase all the contents on the SSD or memory card. Operate with caution.

3.9 STABILISATION SETTINGS



Stabilisation

Main Menu > Stabilisation > Stabilisation

Enable or disable in-body image stabilisation.



- Disable image stabilisation when using a tripod. Otherwise, the image quality will be adversely affected.
- Image stabilisation is not supported when using some of the H System lenses. Make sure to disable image stabilisation to avoid a decrease in image quality when a hint for not supported lens appears on the screen.

Focal Length

Main Menu > Stabilisation > Focal Length

Set the focal length of the lens when using a lens other than XCD and HC/HCD lenses. The maximum adjustable focal length is 499mm.



Make sure to set the focal length correctly. Otherwise, stabilisation performance will be adversely affected.

3.10 WI-FI SETTINGS

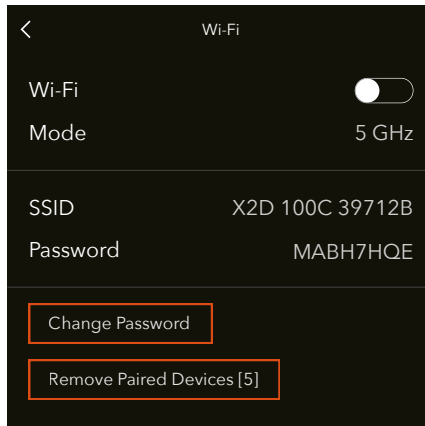

Wi-Fi:

Enable or disable Wi-Fi. If enabled, Bluetooth on the camera will also be enabled automatically, and the WLAN icon  will appear in the upper left corner of Control Screen or Main Menu.

Mode:

Select from 2.4 GHz or 5 GHz.

SSID:

Displays the Wi-Fi name of camera.

Password:

Displays the Wi-Fi password of camera.

Change Password:

Tap to refresh the Wi-Fi password.

Remove Paired Devices:

This can remove all devices that are paired and connected automatically through Bluetooth to the Phocus Mobile 2 app. The value in the brackets indicates the number of paired devices.

Tap this button on the touch display and press the circle button on the camera body to confirm or press the delete button to exit.

If the Remove Paired Devices button is grey on the touch display, it indicates that there were no devices paired before.



- Options for the Wi-Fi mode vary by country or region. Refer to local laws and regulations.
- The display off timer will be set to 60 seconds temporarily when Wi-Fi is enabled. If users tap on the screen or press any buttons, the display off timer will revert to the preset time in the settings.

3.11 GENERAL SETTINGS

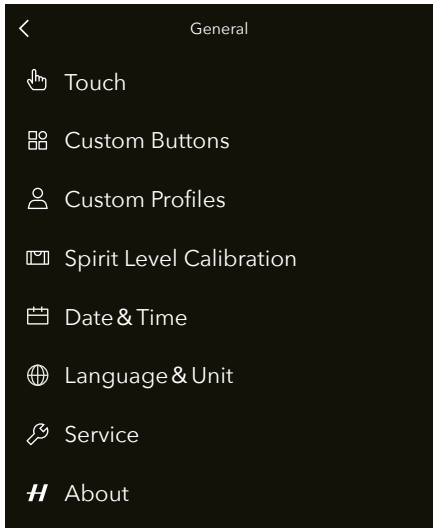

Touch

Main Menu > General > Touch



Touchpad for EVF

Area

Select which area of the touch display is used for Touchpad when using the EVF. Choose from:

- Left (1)
- Right (2)
- Top-Left (3)
- Top-Right (4)
- Bottom-Left (5)
- Bottom-Right (6)

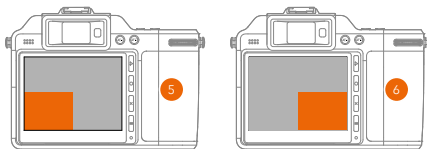
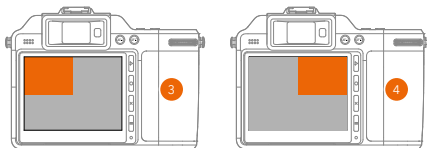
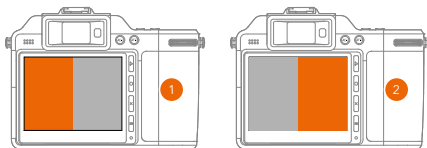

Sensitivity

Select the sensitivity for touch operations between Low, Medium, and High.

Custom Buttons

Main Menu > General > Custom Buttons

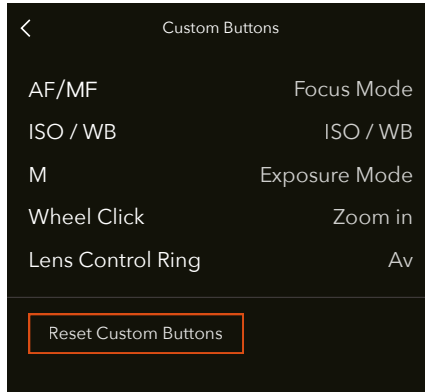

Custom Buttons

The following buttons, scroll wheels, and the control ring on the camera body can be customised. The default functions are listed below. Users can change the settings to preferred functions.

AF/MF Button (AF/MF): focus mode switch by default.

ISO/WB Button (ISO/WB): ISO/WB switch by default.

Exposure Mode Button (M): exposure mode switch by default.

Rear Scroll Wheel (Wheel Click): press the rear scroll wheel to zoom in on the image by default.

Lens Control Ring: aperture adjustment by default. Only some specific lenses have this control ring.

Reset Custom Buttons

Reset the functions for all the custom buttons to the factory settings. Tap the Reset Custom Buttons button on the touch display and press the circle button on the camera body to confirm or press the delete button to exit.

Custom Profiles

Main Menu > General > Custom Profiles

Preset parameters for the camera and save them in different custom profiles. Users can enter the preset mode quickly and use the preset parameters for shooting to improve efficiency by using this function.

After parameter configuration, tap the number of the desired profile and tap Save to save the settings to the selected custom profile.

To use the profile, tap the corresponding profile and tap Load to apply the settings in the profile.



Some camera settings, such as EVF dioptre, top display brightness, and language, will not be saved to the custom profile.

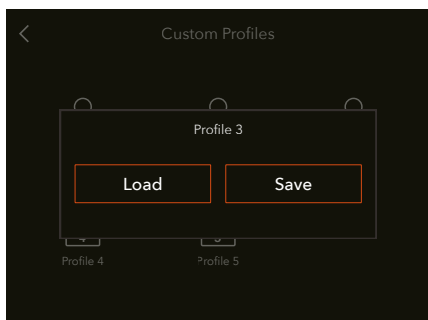
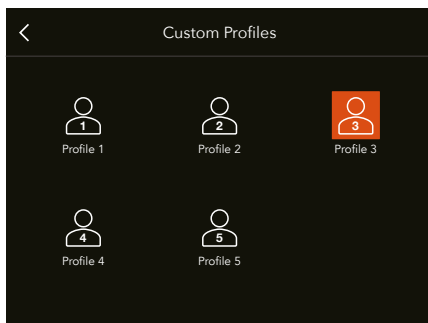

Spirit Level Calibration

Main Menu > General > Spirit Level Calibration

The camera is equipped with an accelerometer to measure the tilt of the camera relative to the horizontal axis and vertical axis. Spirit level calibration can assist in checking the tilt angle of the camera.



In Live View, users can also enter spirit level calibration. Press the circle button on the camera body to switch the display until Exposure Information + Spirit Level appears.

Calibration Modes

There are two modes for the spirit level, Default and Custom. Tap the icon on the upper left corner to select. Default Mode uses the standard factory settings. In Custom Mode, users can set the standard.

Setting Custom Mode

1. Tap the icon on the upper left corner and tap Custom in the pop-up dialogue.
2. Adjust the camera horizontally and vertically to the desired position and tap Calibrate.
3. The two white circles are now moved to the centre position and turn green, indicating that the new spirit level standard is set.

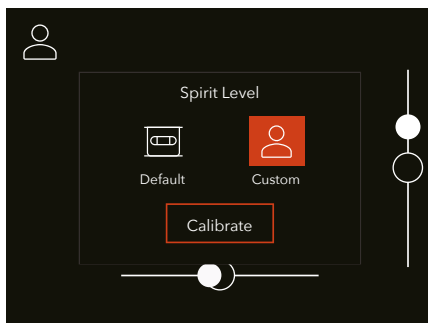

Calibration Instructions

1. Tap the icon on the upper left corner and tap Default or Custom in the pop-up dialogue.
2. Adjust the tilt of the camera left/right and up/down until the solid white circle is in the centre and turns green.

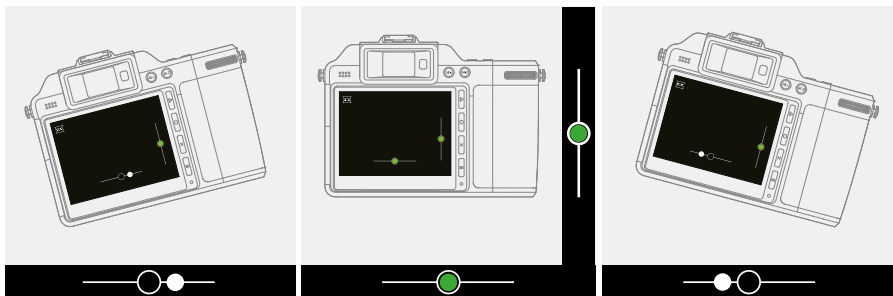

Camera tilted to the left.

Camera aligned horizontally and vertically.

Camera tilted to the right.

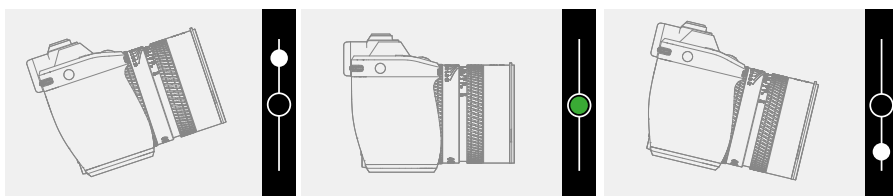

Camera tilted up.

Camera aligned vertically.

Camera tilted down.

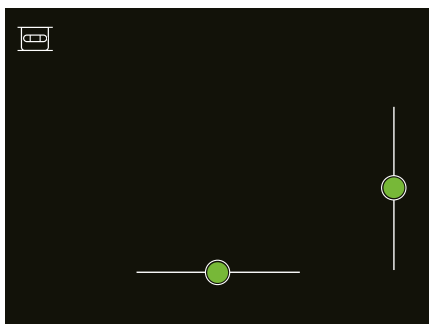

Spirit Level when camera is aligned.

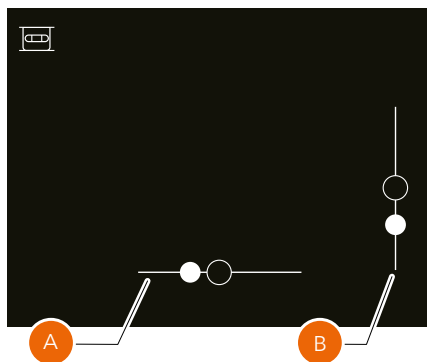

Spirit Level when camera is tilted a little to the right and more down.

Date & Time

Main Menu > General > Date & Time

Tap Date or Time and select year, month, day, hour, and minute respectively.



Language & Unit

Main Menu > General > Language & Unit

Language

Tap Language and select the desired language from the list. Tap any other area on the screen to save the setting.

The following languages are supported:

- English
- Spanish
- French
- German
- Italian
- Swedish
- Russian
- Japanese
- Simplified Chinese
- Traditional Chinese
- Korean

Unit of Distance

Select the unit displayed for the distance scale between metre and foot.

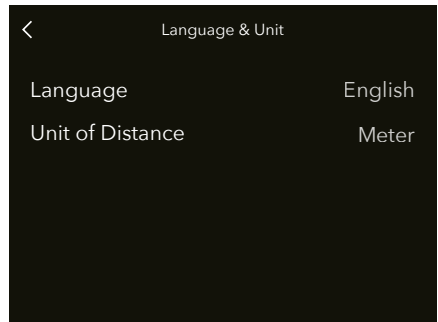

Service

Main Menu > General > Service

Firmware Update

Check the firmware version of the camera and lens.

Follow the instructions below to update the firmware on this page when new firmware is released.

1. Visit the official Hasselblad website www.hasselblad.com to download the latest firmware.
2. Store the firmware in the root directory of the camera SSD or CFexpress memory card.



- If using the camera SSD, make sure to tap Mass Storage in the dialogue on the touch display after the camera is connected to the computer, and then store the firmware to the camera.
- If using a memory card, make sure the memory card is inserted properly into the camera.

3. Power on the camera, go to Main Menu > General > Service and tap Check for Update.
4. Select the firmware file. Make sure that the name and version number of the firmware selected are the same as the downloaded version.
5. Tap Update, and the update dialogue appears. Tap Update in the dialogue to start the firmware update.

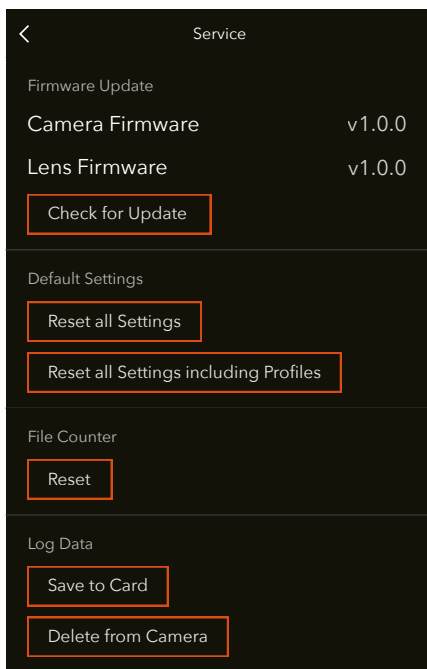

6. The camera will update firmware automatically. It will take several minutes for the update to complete. DO NOT power off the camera or remove the memory card if in use during an update.
7. The camera will show information for a successful update after completed.
8. In the Service screen, check and confirm that the firmware is the latest version.

Default Settings

Reset all Settings: reset all the settings except custom profiles to the default settings.

Reset all Settings including Profiles: reset all the settings, including custom profiles, to the default settings.

File Counter

Tap Reset and press the corresponding button to the right of the touch display. The next captured images will be numbered B0000001.



- After resetting the file counter, if there are images present on the currently used storage, a new folder will be created in the storage in use and set as the default storage folder to avoid images using the same number. The pop-up window after reset will display the name of the new folder. All the images captured after this will be stored in the new folder.
- When the secondary storage is set for backup in the Storage settings, a new folder, if required during reset, will be created in both the built-in SSD and memory card.

Log Data

The log data is the internal data of the camera for repair that can be used by Hasselblad technical support. Users can save or delete the log data using the buttons on the touch display.

Save to Card: tap to save the current log data to the memory card or camera SSD if a memory card is not used. DO NOT remove the memory card or power off the camera when saving the log.

Delete from Camera: tap to delete the saved log data from the camera.

About

Main Menu > General > About

View the product name, model number, and serial number.

Tap Licenses to view the electronic licenses.

Tap Usage to view the total number of lens exposures of the current lens.

Scroll to view Compliance Info, such as electronic labels and ID.

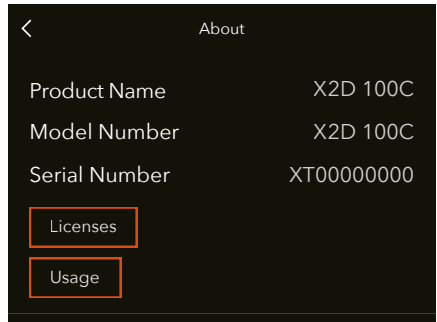

4 PHOCUS MOBILE 2 AND PHOCUS

4.1 PROFILE

The Phocus Mobile 2 app and Phocus software both use HNCS to deliver correct colours.

Expanding the possibilities of the Hasselblad workflow, Phocus Mobile 2 takes the image editing process to a new, portable level, enabling the travelling or studio photographer to have a quicker, more seamless workflow.

Phocus is an image processing and file management application aimed primarily at Hasselblad RAW 3F file handling. Phocus is a license-free software available for both Mac and Windows.

Visit the link below to download Phocus Mobile 2 and Phocus.

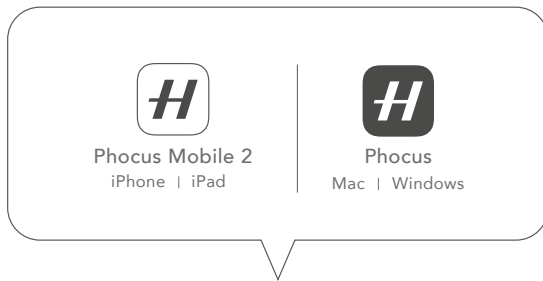

<https://www.hasselblad.com/my-hasselblad/x2d-qr>

4.2 PHOCUS MOBILE 2 APP

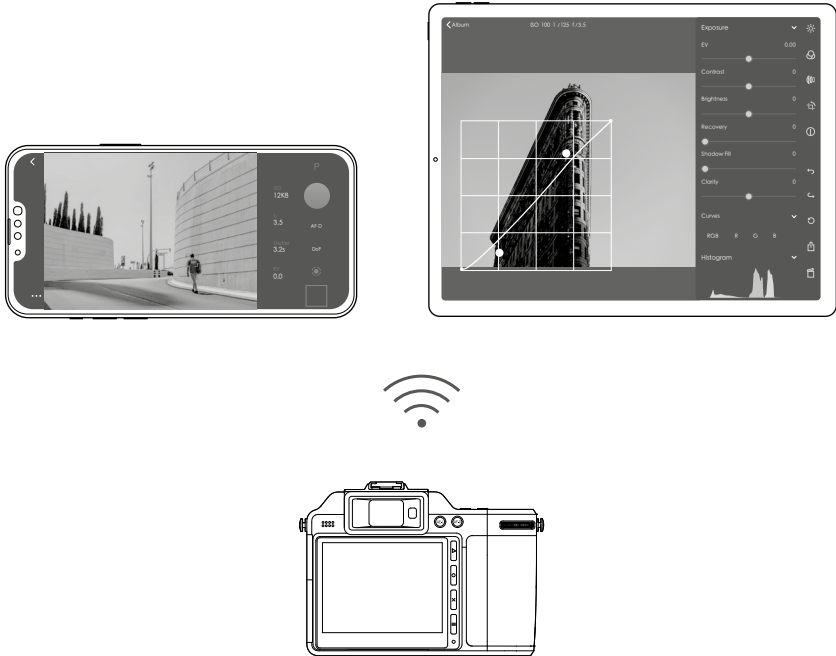

To use Phocus Mobile 2, connect the camera to an iOS device using Wi-Fi. Users can import, edit, and rate RAW and full-quality JPEG images directly on the device. Phocus Mobile 2 supports full-quality image export, tethered shooting, and camera control.

Phocus Mobile 2 is compatible with iPad models with 3GB of RAM or more and with iPhone X or later models running iOS 15.0 or later.

Visit the official Hasselblad website for more information.

<https://www.hasselblad.com/phocus/phocus-mobile-2>

4.3 PHOCUS SOFTWARE

Connecting to Computer

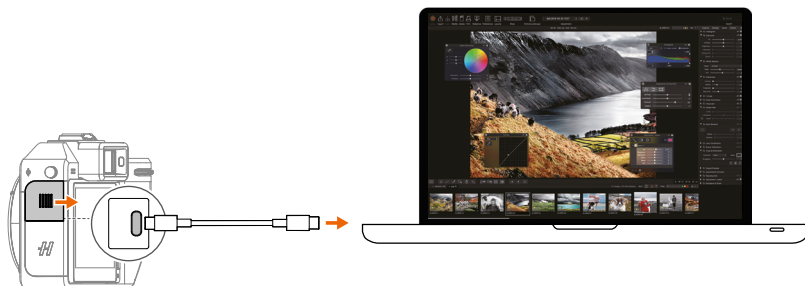

Connect the USB-C port on the camera to a computer using a USB-C cable of USB 2.0 or above. Users can control the camera remotely in Phocus, such as aperture adjustment or exposure time control.

Phocus is compatible with computers with 8GB of RAM or more running on macOS 10.15 or later, or Windows 7 64-bit or later.

When initiating a shot from Phocus, the computer sends a signal to the camera to trigger the shutter and the flash if it is in use. The camera sends the image over the USB connection to the computer, where it is displayed. The image is saved as a 16-bit 3F file in the currently selected folder on the computer hard disk for post-processing, such as colour and exposure adjustment.

Visit the official Hasselblad website for more information.
<https://www.hasselblad.com/phocus>



When connected to a computer, the following applies:

- After connecting to the computer, make sure to tap Skip in the pop-up dialogue on the camera touch display to use tethered shooting.
- The destination medium and location are controlled by the Phocus software. The images cannot be saved to the camera.
- All exposure settings, including ISO, aperture, and shutter speed, are controlled from the Phocus software if users choose to expose from Phocus.

Professional Image Quality

Phocus combines Hasselblad Natural Colour Solution (HNCS) with Digital Auto-Correction (DAC) to provide high digital image quality for the images users create. With Phocus, the moiré effect that can occur on extremely high-resolution images is effectively removed automatically and directly on the raw data, leaving the image quality intact and saving time in post-production.

Phocus and Hasselblad Capture Files



The X2D 100C can capture files and store them as Hasselblad RAW format files or Hasselblad RAW + JPEG formats simultaneously.

Hasselblad RAW files are initially stored in the 3FR format, which is a proprietary Hasselblad format for the temporary storage of images. A 3FR file contains the complete digitised raw image exactly. 3FR information requires further computing power (typically by way of Phocus) to obtain complete development. If developed in Phocus, 3FR files become Hasselblad 3F files with the suffix ".fff". If developed by other RAW processors, the 3FR files will not be converted to 3F but can be exported directly to TIFF and PSD according to requirements.

5 APPENDIX

5.1 CHANGE FROM FOREIGN LANGUAGE

Main Menu > General > Language & Unit

1. Power on the camera and press the menu button twice to enter Main Menu.
2. Tap the general settings icon .
3. Scroll on the screen to find the globe icon .
4. Tap to enter the language setting page and tap to select the desired language from the list.

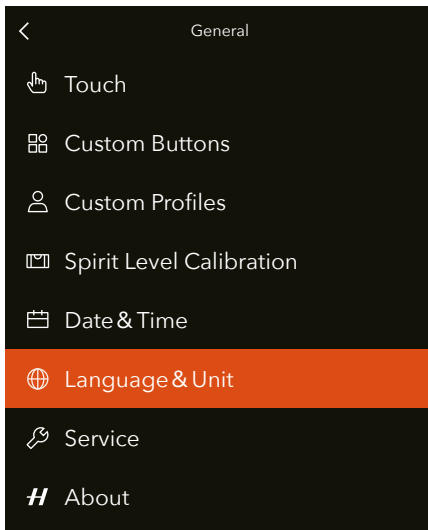

Language Menu

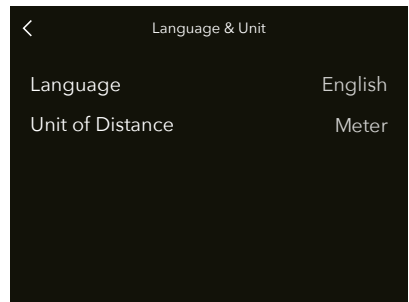

Language Setting

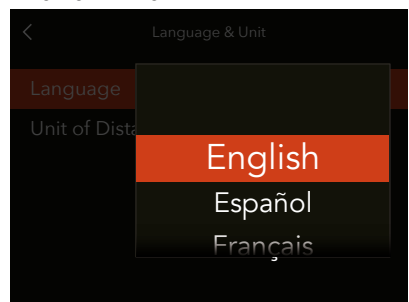

5.2 ERROR MESSAGES

If any error message is displayed

1. Remove the components from the camera.
2. Attach the components to the camera again.

If the error message is still displayed

1. Remove the battery.
2. Remove any connected USB cable.
3. Wait 10 seconds.
4. Attach the battery again.

The camera processor is now reset.

If the error message is still displayed

1. Write down the error message.
2. Contact your closest authorized Hasselblad dealer.

5.3 CLEAN THE SENSOR FILTER

Follow the instructions below:

1. Power off the camera and remove any cable if connected.
2. Press and hold the lens release button. Rotate the lens counterclockwise to remove it.
3. Carefully clean the outside surface of the IR filter by using clean compressed air.

Take several shots of multiple images to test and check each image carefully. Contact the Hasselblad authorised service centre if there are any spots on the images.



- Be careful when attaching/removing the components to/from the camera. This will help prevent damage to the data bus connections.
- After removing the lens, keep foreign objects away from the camera opening. The camera opening is very sensitive. This will help prevent damage to the equipment.
- If using canned compressed air to clean the glass of the IR filter, read the instructions carefully before use. This will help prevent damage to the filter.
- DO NOT remove the glass IR filter from the front of the sensor. This will cause damage to the equipment. Contact the Hasselblad authorised service centre if needed.

5.4 CLEAN THE LENS GLASS SURFACE

Remove Dust

Remove the dust with an air blower or a very soft lens brush.

Remove Smear

If there is smear on the lens glass, do as follows:

1. If you are not sure how to remove the smear, contact the Hasselblad authorised service centre.
2. Clean the lens glass with a high quality lens cleaning solution on a tissue.

5.5 EV VALUE

The EV value (Exposure Value) represents a combination of aperture and shutter speed where all combinations giving the same exposure will have the same EV value.

As an example:

$f/5.6 - 1/125s$ and $f/4 - 1/250s$ has the same EV value = 12.

If the users press AE-L in manual exposure mode and rotate either or both scroll wheels, aperture and shutter speed will change, but the EV value will remain the same.

A change of the EV value by one is the same as changing aperture or shutter speed by one stop.

Examples:

$f/5.6 - 1/125s$: EV 12

$f/8 - 1/125s$: EV 13

$f/5.6 - 1/250s$: EV 13

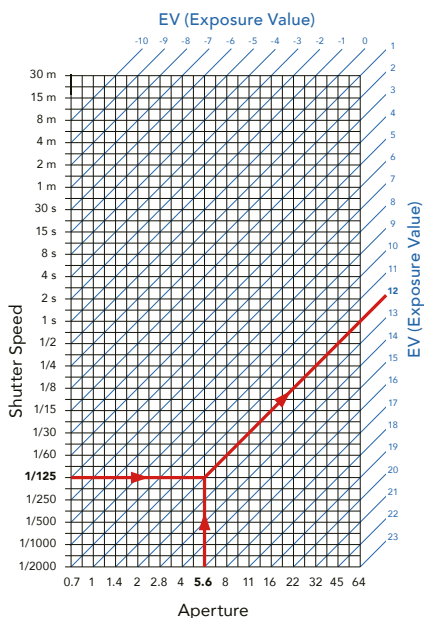

It is important to understand that although two images that were made using the same EV value but with different combinations of aperture and shutter speed will have the same exposure but will not be identical due to different depth-of-field and movement stopping time.

As the EV value is related to the lighting conditions, it can in many cases be an easy way to quickly set the correct exposure. As a start users can use the following guidelines.

| Scene | EV Value @ISO 100 |
|--|-------------------|
| Light sand or snow with clear shadows | 16 |
| Outdoor scene in direct sunlight | 15 |
| Outdoor scene, Cloudy no shadows | 13 |
| Outdoor scene in shadows, clear sunlight | 12 |
| Sunset | 12 |
| Night scenes in city lights | 7-8 |
| Indoor, home | 5-7 |

The table shows EV values for ISO 100. If using another ISO setting the EV value should be modified as follows:

ISO 200: EV +1

ISO 400: EV +2

ISO 800: EV +3

and so forth.

More information here: https://en.wikipedia.org/wiki/Exposure_value

5.6 ACCESSORIES

XH Lens Adapter

CP.QT.00000290.01

The XH Lens Adapter can be used to mount an HC/HCD lens onto the X2D 100C camera.

The XH Lens Adapter widens the X2D 100C lens choices to include all 12 H-system HC/HCD lenses, and accessories including a macro converter and 3 extension tubes.

The HC/HCD lens range includes a 24 mm wide-angle lens, a 300 mm telephoto lens and a 100 mm f 2.2 lens, delivering small depth-of-field range and a beautiful, smooth Bokeh.



Only certain functions of the camera are supported when using an H System lens.



XH CONVERTER 0,8

CP.HB.00000627.01

The XH Converter 0,8 is an accessory for using HC/HCD lenses on X System cameras. It reduces the focal length of the attached lens by a factor of 0,8x as well as increases the maximum and minimum aperture with 2/3 stops.

The following cameras and lenses are supported:

- Hasselblad X System cameras, X2D 100C with firmware 1.0.0 or later, X1D with firmware 1.25.0 or later, or X1D II 50C/907X/CFV II with firmware 1.4.0 or later.
- All Hasselblad HC and HCD lenses, except HC120 and HC120-II with firmware older than 18.0.0.



- Only certain functions of the camera are supported when using an H System lens.
- Lenses with firmware 18.0.0 to 19.0.3 must be updated to 19.1.0 or later. Lenses with firmware older than 18.0.0 will have manual focus only.
- HCD lenses were originally designed for a smaller format than HC lenses. Therefore some reduction of performance in extreme corners can occur.

XV Lens Adapter

CP.HB.00000241.01

The XV lens Adapter is used to attach Hasselblad V System lenses to the X2D 100C. Compatible with all V System lenses (C, CF, CFi, CFE, CB, F and FE)



- This requires the electronic shutter function of the X2D 100C to be activated.
- Lens corrections for V System lenses are available with Phocus version 3.4 or later. Note that they have to be manually selected.



Tripod Mount Ring 75mm

CP.HB.00000217.01

The tripod mount ring is designed to fit the XH/XV lens adapters and the X Converter 1.7, giving additional support when using long or heavy HC/HCD or V System lenses on X System camera bodies. The tripod mount ring can be fitted to 1/4" and 3/8" tripod threads or the Hasselblad Quick Coupling Plate H.



XPan Lens Adapter

CP.HB.00000036.01

The XPan Lens Adapter is used to attach lenses that was made for the XPan camera. Available XPan lenses were 5,6/30mm, 4/45mm and 4/90mm.



XPan Lenses had no built-in shutter. Consequently, they can only be used when the electronic shutter of the camera is activated.



Battery Charging Hub

CP.HB.00000397.01 (EMEA)

CP.HB.00000395.01 (United Kingdom)

CP.HB.00000392.01 (North America/Japan)

CP.HB.00000396.01 (China)

CP.HB.00000393.01 (South Korea)

CP.HB.00000394.01 (Australia/New Zealand)



Streamlining the battery charging process, the Hasselblad Battery Charging Hub contains dual slots that support the simultaneous charging of two batteries. An integrated USB Type-C connector supports mains power via an included power supply or from common external USB battery banks (purchased separately). Front-facing LEDs indicate status and capacity when charging, or users can use the Battery Charging Hub to check battery levels simply by inserting a battery and pressing a single button.

Optional HC Lens Accessories

H 13, 26, and 52 Extension Tubes

CP.QT.00000228.01

Extension Tube H 13mm

CP.QT.00000223.01

Extension Tube H 26mm

CP.QT.00000233.01

Extension Tube H 52mm

The Extension tubes attach between the XH Lens Adapter and the HC lens to reduce the close focusing distance for close up photography. They are available in three sizes: 13mm, 26mm and 52mm. As the X2D 100C has a TTL light metering system, exposure compensation is automatic.



Converter H 1.7x

CP.QT.00000239.01

The Converter H 1.7x is mounted between the XH Lens Adapter and the HC lens. Then Converter H 1.7x increases the focal length of a lens by a factor of 1.7x. It features the same outstanding optical and mechanical quality as the elements in the Hasselblad H-lens series.



Tilt/Shift Adapter HTS 1.5x

CP.QT.00000232.01

The HTS 1.5x is designed to work with HCD24, HCD28, HC35, HC50, HC80 and HC100 lenses. It has a converter factor of 1.5 times and allows for +/- 10 degrees of Tilt and +/- 18 mm Shift. AF with the X2D 100C works even if the adapter is set for Tilt and/or Shift. Meta Data for Tilt and Shift amount is not added to the image file when using the X2D 100C, and automatic lens corrections will not be applied in Phocus. This is a feature unique to the H5D and H6D Cameras.



Optional Accessories

Pro Shade V/H 60-95

CP.QT.HB000021.01

An adjustable bellows lens shade that provides highly efficient protection against stray light. The compact, flat folding design saves space in the equipment case. It also features a filter holder for glass, gelatin, or plastic filters.



Pro Shade Adapters

CP.QT.HB000024.01

Proshade Adapter 67mm

CP.HB.00000073.01

Proshade Adapter 77mm

CP.QT.HB000025.01

Proshade Adapter 95mm

67 mm, 77 mm and 95 mm adapters with bayonet mount for HC lenses. Features lock to provide positive and secure attachment.



UV Sky Filters

CP.HB.00000024.01 Filter UV-Sky 67mm

CP.HB.00000086.01 Filter UV-Sky 77mm

CP.HB.00000087.01 Slim Filter UV-Sky 95mm

Absorbs UV radiation and reduces blue haze without affecting colours. Also protects the front lens surface. Particularly recommended when the camera is used in harsh conditions.

Available in three sizes to suit various lenses: 67mm, 77mm and 95mm.



Pola Filters

- CP.HB.00000089.01
Polarizing Filter 67mm
- CP.HB.00000090.01
Polarizing Filter 77mm
- CP.HB.00000091.01
Polarizing Filter 95mm



Reduces non-specular reflections and glare.
Increases colour saturation in general. Can intensify a blue sky. Available in three sizes.

Tripod Quick Coupling H

CP.HB.00000070.01

Mounted on a tripod, this accessory facilitates rapid attachment and removal of the camera. The camera is firmly held in an exact and repeatable position. Works with the Tripod Mount Ring 75mm.

Two integrated spirit levels make horizontal positioning of the camera easy. The Tripod Quick Coupling H fits 1/4" and 3/8" tripod threads and has a safety catch. Fits all H System cameras and virtually all V System cameras. X System cameras can be mounted by using the Quick-Coupling Plate (CP.QT.00000212.01).



This content is subject to change without notice.
Download the latest version from



<https://www.hasselblad.com/my-hasselblad/downloads>

HASSELBLAD and **H** are trademarks of Victor Hasselblad AB.

Copyright ©2022 Victor Hasselblad AB. All Rights Reserved.